



**SOLAR SCREEN
TOOLS & LIQUIDS**
SMART INSTALLATION GEAR



INDEX

KNIVES & SCISSORS

100-003	19
100-004	18
100-023	16
100-024	18
100-026	16
100-180-BLACK	23
100-300	22
100-45-C	18
100-A-1	21
100-A-2	21
100-A-3	21
100-A-5	22
100-A300GR	21
100-A300R	21
100-AK-1	19
100-AK-1/5B	19
100-AK-4	20
100-AK-5	20
100-CL	26
100-CMP-1	33
100-CMP-1/DX	33
100-CMP-2	33
100-CMP-3	33
100-D1000	18
100-D400	19
100-DA-1	23
100-DL-1	26
100-EXL	26
100-FWP-1	24
100-H-1	28
100-HOK-1	32
100-L-5	27
100-L-5-AL	27
100-L1	24
100-L2	24
100-L3	25
100-L500GR	24
100-LH70	17
100-MC-45	32
100-ML	27
100-NA-1	23
100-NH-1	28
100-NL-AL	25
100-NOL-1	25
100-PA-2	22
100-PC-L	32
100-PL-1	25
100-PRC-3/C	29
100-RTY-1/C	29
100-RTY-2/C	30
100-RTY-2/DX	30
100-RTY-2/G	30
100-RTY-2/NS	30
100-RTY-3/G	31
100-RTY-3DX	31
100-RTY-4	29
100-S	23
100-SAC-1	20
100-SCS-1	34
100-SCS-2	34
100-SCS-3	34
100-SCS-4	34
100-SL-1	25
100-SOC	17
100-SPC-1/40	23
100-SVR-2	20
100-TK-3M	31
100-TK-4	31
100-TS-1	18
100-XA-1	22
100-XH-1	28
100-XH-AL	28
100-XL-2	26

120-023R	16
120-LH70R	17

SPARE BLADES

120-020	42
120-023R	43
120-AB SERIES	37
120-AB-10	38
120-AB-10S	38
120-AB-50	38
120-AB-50B	38
120-AB-50S	38
120-AB-S SERIES	37
120-ABB-10B	38
120-ABB-50	38
120-ASB-10	38
120-ASBB-10	38
120-BD-100A	36
120-BS-08/6B	41
120-BS-10B	41
120-BSF-6B	41
120-DB	45
120-DC-2	45
120-DC-3	45
120-DC-4	45
120-DC-5	45
120-EXCELBLACK	37
120-FWB SERIES	37
120-GSB-1S	41
120-GSB-2S	41
120-HB-20	39
120-HB-5B	39
120-HBB-5B	39
120-KB-25	43
120-KB-5/30B	42
120-KB4-F	42
120-KB4-R	42
120-KB4-S	42
120-KB4-WS	42
120-LB SERIES	38
120-LB-10	38
120-LB-10B	38
120-LB-50	38
120-LB-50B	38
120-LBB SERIES	38
120-LBB-10	38
120-LBB-50	38
120-LBD-10	38
120-LH70R	43
120-MCB-1	43
120-PB-800	43
120-PB450	43
120-PIB45-1	40
120-RB18-2	40
120-RB28 SERIES	40
120-RB28-10	40
120-RB28-2	40
120-RB45 SERIES	40
120-RB45 SERIES	40
120-RB45-1	40
120-RB45-10	40
120-RB60-1	40
120-SAB-10	36
120-SUB-50	36
120-TSB-1	43
300-002	44
300-004	44
300-015R	44
300-BSC-21P	44

SCRAPING & CLEANING

150-033	52
150-034	52
150-110	52

150-111	52
150-112	52
150-113	52
150-113	52
300-001	53
300-003	53
300-003SM	53
300-005	53
300-006	58
300-006-CMB	58
300-009	59
300-009BL	59
300-009C	59
300-010	60
300-010T	60
300-011CMB	58
300-012	58
300-013	58
300-014	59
300-015	53
300-016	52
300-020	50
300-020	50
300-021	50
300-022	48
300-023	48
300-026	51
300-027	51
300-028	51
300-029	49
300-031	56
300-032	49
300-035	52
300-040	48
300-044	51
300-045	49
300-049	49
300-050	55
300-050	55
300-051	55
300-051	55
300-052	55
300-052	55
300-363	51
300-GSR-1/3B	55
300-GSR-2	54
300-SC5P	54
300-SCR-L	54
300-SCR-M	54
300-SCR-S	54
350-150	56
350-151	56
400-014	56
500-050	48

CUTTING TOOLS

250-010	66
250-011	66
250-012	66
250-013	66
250-014	66
250-015	66
250-016	66
250-017	66
250-018	66
250-CB001	63
250-CB100	63
250-CB155	63
250-CB200	63
250-CB50	63
250-CM-A4	67
250-CM-A3	67
250-CM-A2	67
250-CM-A1	67
250-CG	68

250-CG120	68
250-CG140	68
250-CG90	68
250-CG90	68
250-CM SERIES	67
250-ML12	67
250-ML8	67
250-MQR	67
250-SERIES	66
350-204	64
350-2044	64
350-206	65
350-207	65
350-208	65
350-209	65
350-213	65

SQUEEGEES

150-001	79
150-002	79
150-003	79
150-003BT	78
150-003GR	78
150-004	79
150-004GR	78
150-005	88
150-006	95
150-006S	95
150-007	95
150-008	91
150-008S	91
150-010	89
150-011	87
150-012	95
150-013	87
150-015	72
150-015BL	72
150-015PT	72
150-015WT	72
150-016	72
150-017	81
150-018	90
150-019	88
150-020	90
150-021	90
150-022	89
150-023	89
150-026	92
150-027	87
150-028	86
150-029	86
150-030	87
150-031	82
150-031S	82
150-032	82
150-033	90
150-034	90
150-035	92
150-037	70
150-038	82
150-039	98
150-041	70
150-042	97
150-042L	98
150-042S	97
150-042SM	97
150-043	98
150-043L	98
150-046	91
150-048	96
150-049	96
150-050	95
150-051	96
150-052	80
150-054	96



KNIVES & SCISSORS

Discover our wide range of cutters: from safety blades to precision knives and specific cutting tools, find the cutter that suits your needs.

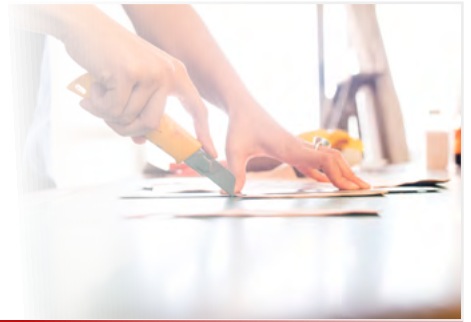

SPARE BLADES

Stay sharp by refilling your cutting equipment with a wide range of blades, large and small. Ensure you always have quality blades on hand for uninterrupted work and precise, efficient cutting without damaging the glass.



SCRAPING & CLEANING

Prepare the surface of your windows before applying the adhesive with our selection of scraping and cleaning tools. Remove glue, paint and dirt residue with our professional scrapers and cloths.



CUTTING TOOLS

Simplify the cutting of your adhesive with our range of cutting aids. Cut your accurately and with no offsets, for a perfect result.



SQUEEGEES

Get the perfect finish on your adhesive with our range of professional grade squeegees. Our squeegees provide a smooth and even finish by removing air bubbles and excess water.



SMART TOOLS

Great tools for precise and fast installation of adhesive, even in the most complex installations. With our selection of innovative tools, you can apply your adhesive with greater ease and efficiency, for a perfect result.





INSTALLATION TOOLS

A complete range of tools designed to make the installation of adhesive on glass surfaces quick and easy. Professional-grade tools for fast, accurate installations that will save you time on your projects.



HEAT GUNS & MORE

Use thermal tools to control the heating and shaping of your materials. With their thermal controls, our tools allow you to obtain a precise and uniform result. Additionally, their ergonomic design and ease of handling make them comfortable and safe to use for long periods of time.



WORKSHOP GEAR

Our products help you optimise your workspace safely. With our range of workshop equipment, you will benefit from a comfortable, fast and safe installation, for an optimal result.



LIQUIDS

Our high-quality products include application fluids to facilitate installation, cleaning solutions to remove impurities and stripping solutions to facilitate the removal of existing adhesive. Use our liquids to keep your jobsite clean



PROMOTIONAL TOOLS

Today's customers often know exactly what they want. But how do you convince your customer that you can offer them the best? That you have exactly what they need? Our support materials will help you do just that. For each specific topic, we have something that can help you with your sales or your presentation.

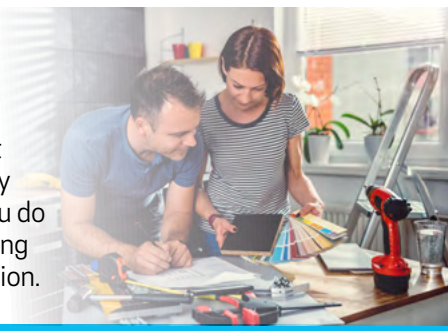

COVER STYL TOOLS

Get the job done professionally with our range of Cover Styl vinyl preparation and application tools. Our tools have been specifically designed to help you achieve a perfect installation, efficiently. Handle the vinyl easily without the risk of damaging it. Our selection of tools will allow you to attain a seamless result in less time.





WEBSHOP

SUBSCRIBE NOW



ORDER EASILY ON OUR ONLINE STORE

Discover our online store, a simple and user-friendly interface that allows easy navigation through all our products. This platform is designed to provide a quick, user-friendly, and secure shopping experience. You can easily browse through all our products with a simple and intuitive interface. With to our advanced search system and product filters, you can easily find the tools you need for your installations. We are proud to offer a wide selection of high quality professional tools at competitive prices on our online store, as well as top-notch customer service to answer all your questions and help you with your purchases.



SOLAR SCREEN
SMART FILM SOLUTIONS

solarscreen.eu
webshop.solarscreen.eu

OUR DNA AND SOME FIGURES

40+ YEARS
OF EXPERIENCE

+1600
REFERENCES

+65,000
ROLLS IN STOCK

YOU ARE UNIQUE

So is the service
you deserve
from us!



A SALES RELATION WITH US

- Dedicated contact person
- In your language
- Going the extra mile
- Flexible for your business needs
- Human, dynamic & fun
- Since '84

AT SOLAR SCREEN, YOU CAN COUNT ON

- Wide range of products
- In stock
- At a competitive price
- Without MOQ
- Shipped the day of your order
- Controlled CO₂ footprint

YOUR NEEDS SIMPLY DELIVERED

◀◀ Our daily commitment!

YOUR GROWTH OUR DRIVE

Long - term,
the only way we
see our relation!



MULTIPLE SOLUTIONS

- Building product awareness
- Strong technical expertise
- In - house trainings
- Customi marketing for your brand
- New products through R&D
- Investing for you

A FURTHER STEP TOWARDS SUSTAINABLE DEVELOPMENT

Solar Screen is now certified as a CO₂-neutral logistics company. 100% of the CO₂ emitted inbound transport is offset: offset of 11,151 tonnes of CO₂ compared to 2019.



Building Kits Installation

Prepare your work site with our complete kit that will allow you to easily start the installation of your windows. It includes all the necessary tools for a successful and seamless installation. With this kit, you can work in complete serenity and achieve a professional result.

Small Building Kit

100-SVR-2

OLFA
Professional Cutter



120-ASBB-10

OLFA
9 mm Black Ultra
Sharp Snap - Off Blades



300-013

SCRAPERITE
The Wide Gripper



550-WG

WATER GUN 1L
The Ultimate Sprayer



150-019

BLACK EDGE
Squeegee



150-SQ10

SQ
Squeegee Straight
Corners



150-111

BIG TURBO
Cleaning Squeegee



Large Building Kit

100-PA-2

OLFA
Auto - Loading Auto



120-ABB

OLFA
9 mm Black Ultra

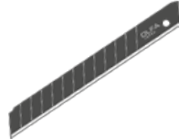

120-DB

SOTT
Snap - Off Blade Container



300-015

TRIUMPH MK III
Angled Super Scraper



150-052

DUNLOP
Squeegee



150-051

BLUE MAX
The Orange Crush



150-043

FUSION - 8
Hand Grip



150-035

5 - Way Tool



150-LM10

OMEGA 10
Squeegee



150-SQ10

SQ
Squeegee
Straight Corners



400-016S

SOTT
Professional Toolbag



400-017S

SOTT
Belt



550-4007

SOTT
Pressure Spraybottle
HOZELOCK



600-F0355

SOTT
Film-On



600-SC02FLES

SOTT
Surface Cleaner II



PROTECTOR

AUTOMOTIVE INSTALLATION KITS

Prepare your vehicles with automotive Installation Kit. This complete kit contains all the tools you need for an easy and professional installation. With our Automotive Installation Kit, you can ensure that the installation will be done without any problems or imperfections.

SMALL AUTOMOTIVE KIT

100-SAC-1

OLFA
Professional Cutter



120-AB-10S

OLFA
9 mm Stainless Steel Snap
Off Blades

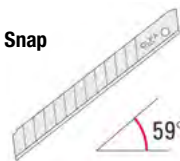

120-DB

SOTT
Snap - Off Blade Container



150-LM10

OMEGA 10
Squeegee



150-029

GOLD EZ
Squeegee



300-026

SCOTCHBRITE
Scrub Pad - Thin



400-255

SOTT
Toolbag Mini



550-WG

WATER GUN 1L
The Ultimate Sprayer



400-HM-2

HEATMASTER2
Heat Gun - 2000 W



LARGE AUTOMOTIVE KIT

100-SAC-1

OLFA
Professional Cutter



120-AB-10S

OLFA
9 mm Stainless Steel Snap
Off Blades

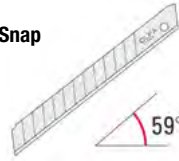

120-DB

SOTT
Snap - Off tBlade Container



300-021

ULTRACLEAN
dust-free, micro
fibre cloths



300-026

SCOTCHBRITE
Scrub Pad

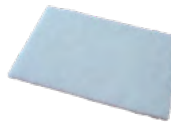

600-F0355

SOTT
Film-On



150-029

GOLD EZ
Squeegee



150-007

The Blue Max



150-015BL

Teflon Blue - Soft

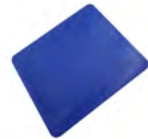

150-033

Lil' Chizler



150-041

Felt Squeegee



600-Z0440FLES

SOTT
Spray-N-Gone



150-042SM

SOTT
5 Short Grip Fandle



150-075

SPEEDWING
Lime 11 cm

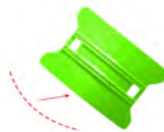

150-090

The Hustler

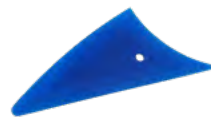

150-3MPA

3M
Gold Squeegee



550-4075

SOTT
Pressure Spraybottle
HOZELOCK



400-016S

SOTT
Professional toolbag



400-017S

OLFA
Belt



400-HG2120E

STEINEL
Heat Gun Expert



PROTECTOR



PROTECTOR PPF RECOMMENDED TOOLS

PROTECTOR OFFERS A WIDE RANGE OF TAILOR
MADE TOOLS READILY AVAILABLE TO INSTALL PPF.

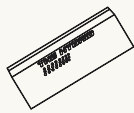

150-048
The Hybrid 13 cm



150-042
Handle 13 cm



150-101
The Finisher



150-PP3
The Pink Shaved Squeegee



300-032
XXL Towel



300-029
Microfibre



100-SAC-1
OLFA Professional Cutter



120-SAB-10
OLFA 30° blades



350-221
The Needle



550-WB10
Waterbomb 10L



600-T800FLES
T800



600-SC02FLES
Surface Cleaner



600-F0355
Film-On



300-049
Clay Bar



600-T900
T900

Protector



DRIVE WITH
CONFIDENCE

OUR PAINT PROTECTION

PROTECTOR GLOSS

THE SHINE ENHANCER

▼▼▼▼▼	▼▼▼▼▼	▼▼▼▼▼	▼▼▼▼▼

Protector Gloss is for those who desire a radiant, high-gloss finish. It amplifies your car's natural color and shine, giving it a freshly-polished look every day

PROTECTOR MAT

THE SLEEK PROTECT

▼▼▼▼▼	▼▼▼▼▼	N/A	N/A

Protector Mat caters to enthusiasts of a sleek, matte finish. It transforms your vehicle's appearance with a stylish and modern flat finish while offering the same robust protection.



Our Suppliers

SOTT

PROTECTOR

 **COVER STYL**

SIEVERT

OLFA

SCRAPERITE®

STANLEY

X-ACTO

NT Cutter
EVER NEW & EVER SHARP

3M

STEINEL

UNGER

© All rights reserved. All product and company names are trademarks™ or registered® trademarks of their respective holders. All specifications are subject to change without notice.



KNIVES & SCISSORS

Discover our wide range of cutters: from safety blades to precision knives and specific cutting tools, find the cutter that suits your needs.





SOTT® Backing - Paper Liner - Cutter

100-023



- Bigger Handle
- Powder coated pedestal to avoid sticking

Glides by perfectly between vinyl and paper liner. Foot is coated so it won't stick on the adhesive side. The handle is longer than conventional slitters and provides better grip.



5 BLADES INCLUDED



QUICK TIPS

Recommended knife blades:



120-023R

Price per unit

Squeegee With Backing Slitter ^{NEW}

100-026



- Medium stiffness
- 12 cm wide

Golden squeegee with a backing slitter on one side. As the blade is safely enclosed in the blade holder, you can be sure not to injure yourself while scraping.

THE BLADE IS REPLACEABLE



QUICK TIPS

Recommended knife blades:



120-023R

Price per unit

Spare Blades for SOTT® Backing Cutter

120-023R



- 10 blades per box



QUICK TIPS

Specially for Backing Cutter:



100-023



100-026

Price per unit



- Quick and easy cutting without damaging the substrate
- Fast cutting of from a roll while it's still in the printer or cutting plotter.
- Fast cutting of to size when it's already on the car.

This handy little knife is a 'must have' for every fast fitter. Not only that, this knife can do much more as it was originally intended for the opening and cutting of envelopes, paper, cardboard boxes, etc.

You know the problem: the is on the car - get your knife - blade out - cut the - and then pray you haven't cut in to the paintwork.

There's a much easier and less stressful way. Just take your easy cutter and cut your s to size in one go, without fear of cutting in to the paintwork.

The secret is in the shape and construction of the easy cutter. It has a Plastic head with a flat underside and an angled stainless steel blade mounted on the inside of the head. The runs between the top and underside of the head, so the blade can't possibly come in contact with the substrate.

It's also 100 % safe as the blade is concealed in the head. So having to slide the blade back in before putting the knife in your pocket or tool bag is a thing of the past.

The easy cutter is manufactured from durable plastic with rubber inlays
In short: a simple tool for quickly cutting without a lot of hassle.

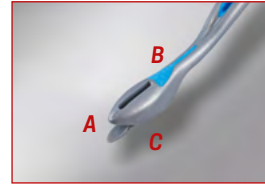

There is a 'sight' at the front that allows the cutting line to be followed accurately. Handy and clever.



This ergonomic hand grip with soft rubber inlay ensures a perfect grip allowing effortless cutting of both straight and more intricate cuts.

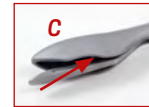

Built in blade

A knife that DOES NOT cut into the SUBSTRATE

- CUTTING SECURITY S
- CUTTING BANNER MATERIALS
- CUTTING PVC S
- CUTTING WINDOW S
- EASY TO USE AT YOUR PRINTER
- EASY TO USE AT YOUR PLOTTER

QUICK TIPS ATTENTION: the blade cannot be replaced

Price per unit



- Super light
- Aluminium handle

Cutting wide 152 cm pieces of on your cutting table in one go? This seems familiar to you?

With the Eez Reach Cutter, this is now a distant memory. The long handle allows you to cut through sheets of or paper as large as 160 cm with one movement. Attached to the handle is a 70 cm long aluminium handle with a smooth head at the front, in which a super-sharp blade is placed.

The spoon at the bottom of the head slides easily over the cutting table without damaging it and ensures that the goes over the spoon, into the head and is cut by the knife.

The easy cutter is manufactured from durable plastic with rubber inlays
In short: a simple tool for quickly cutting without a lot of hassle.

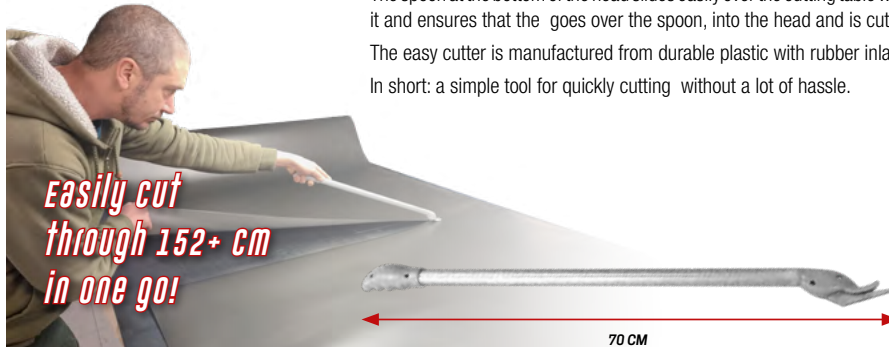
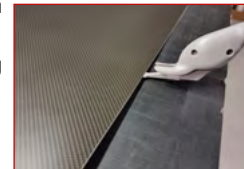

Easily cut through 152+ cm in one go!

- THE BLADE IS SECURELY POSITIONED IN THE HEAD
- SMOOTH CUTTING HEAD SO THE OR PAPER DOES NOT STICK WHILE CUTTING
- LIGHT ALUMINIUM HANDLE
- THE KNIFE IS REPLACEABLE

QUICK TIPS Recommended knife blades:  100-LH70R

Price per unit

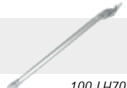

- 10 blades in carton per box

QUICK TIPS Specially for EEZ Reach Cutter:  100-LH70

Price per pack



- Incredible as it may seem, the TS-1 cuts only the top layer!

This OLFA cutter is your top choice when you want to cut only the top sheet. Its unique design lets you cut the top layer while preserving those below. While the cutter is great for cutting coupons and printed articles, you also can use it on cardstock, thin s, plastic sheeting, tape and more.

Good For: cutting a single sheet of paper, newspaper and thin vinyl.



paperworld & creativeworld
Creative Impulse 2012



Spare blade: 120-TSB-1



Price per unit



- Cut only the top or bottom layer with precision
- 6 Depth settings

This handy slitter from NT is ideal for cutting to a specific depth with precision. Cut adhesive without touching the backing paper/supporting material, or, cut the carrier without touching the . It is all possible with this slitter.

The depth is adjustable to 6 different positions. The blade in the plastic housing is made of superhard Tungsten Carbide and provides a perfect cut. The blade is not replaceable.



Price per unit



- Rotary blade inside

The OLFA 100-45-C Maru Rolling Scissors features a rotary blade and a flat bottom for controlled cutting without damaging the surface underneath.

The tungsten tool steel blades can also be quickly and easily replaced at the end of their life. The handle is smooth and lightweight, making using this cutter comfortable and easy.



Spare blade: 120-RB45-1



Price per unit

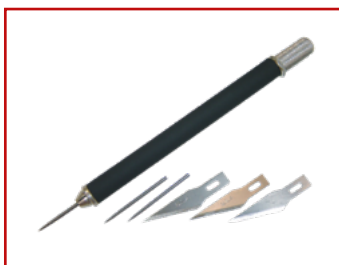

- 2 in 1: Artknife and Air Release Tool

Covered with soft rubber this deluxe combination of a knife and needle with a pen like shape has a comfortable yet sturdy grip.

3 needles are included which can be used to release air bubbles or peeling vinyl.

EXTRA: 3 X-ACTO BLADES.



Recommended knife blades: 120-020



Price per unit



- 2 in 1: Artknife and Air Release Tool

High quality designer knife in special edition from NT.

This double-ended holder is multi-functional with a blade on one side and a needle on the other side to release air bubbles.

Both blade and needle can be easily screwed onto the holder.



Recommended knife blades:
120-KB-25, 120-SAB-10, 120-BD100

Price per unit

NT® Cutter Designer Knife **NT Cutter**
EVER NEW & EVER SHARP

100-D400



- Perfection in cutting with "the perfect touch"

This knife enables perfect curves and openings to be cut in the without damaging the car paintwork or substrate as it allows more "feel" during cutting as the correct cutting pressure is easier to determine. Fits perfectly in the hand. The blades can not only be placed in the head in the straight, traditional way, but also in the "designers-way".



Place the blade in the rear of the head to create an extremely sharp cutting angle for perfect uniform cuts. This art knife is manufactured from extremely durable plastic with a stainless steel head.

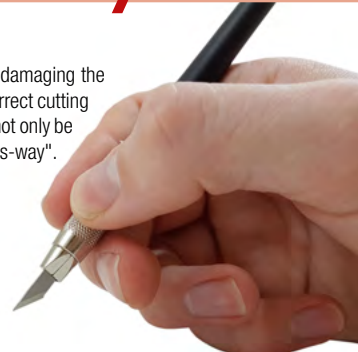

QUICK TIPS

Recommended knife blades: 120-KB-25, 120-SAB-10, 120-BD100

Price per unit

X - ACTO® Art Knife Aluminium **X-ACTO**

100-003



- 2 Needles included

Well-known X-Acto knife. Made of aluminium. Only useable with the X-Acto blades. 2 needles are included to release air bubbles.



QUICK TIPS

Recommended knife blades: 120-020, 120-KB4-S

Price per unit

OLFA® Standard Art Knife with 25 Blades **OLFA**

100-AK-1



- With contoured grip

Standard-duty art knife perfect to delicate work with it's acutely pointed blade for precision. OLFA's pen-like knife features a contoured handle and textured grip for comfort and stability. Quick-spin easy blade change. This blade made from high quality carbon tool steel is produced using OLFA's precise multi-step production process for unparalleled sharpness and superioredge retention.

- Lightweight, contoured handle.
- Quick-spin blade change.
- Includes (25 multi-purpose 30° art blades (KB).



QUICK TIPS

Recommended knife blades: 120-KB-25



Price per unit

OLFA® Art Knife **OLFA**

100-AK-1/5B



- 2 Needles included

OLFA Art Knife with a pen type contoured handle. Light as a feather, this knife helps you to cut detailed patterns with the utmost precision.



QUICK TIPS

Recommended knife blades: 120-KB-25



Price per unit

OLFA® Comfort Grip Precision Art Knife with 5 blades **OLFA**

100-AK-4



- Contoured handle and textured grip for precision

Precision art knife for professionals, part of the Comfort Grip series featuring anti-slip cushion grip handles.

Comfort Grip handles provide premium comfort and are acetone resistant. The perfectly balanced design for accuracy and stability combined with the anti-roll device for convenience and safety.

Quick spin, easy blade change.

- Acetone-resistant handle
- Quick-spin blade change
- Includes 2 Precision 120-KB4-S, 1 Chisel 120-KB4-F and 1 Curved Carving 120-KB4-R art blades.



Recommended knife blades:
120-020, 120-KB4-F, 120-KB4-R,
120-KB4S, 120-KB4-WS



Price per unit

OLFA® Standard Art Knife with 30 Blades and Needle **OLFA**

100-AK-5



- Precision on a very high level

Designer's Art Knife with a spatula edge. The package includes 30 blades and a needle. The square-shaped spare blade case works as a standish when connected to the blade cover. The accessories needle marks on plastic

modeling and peels labels. They come in handy spatula at the top end smoothes adhesive materials and molds a shape in clay. Ideal for designers, hobbyists, craftsmen. Besides, dental technicians choose the AK-5 for making up denture molds.



Recommended knife blades:
120-KB-25, 120-KB5/30B



Price per unit

PROFESSIONNELS

9
mm

CUTTERS

OLFA® Professional Cutter **OLFA**

100-SVR-2



- Autolock; for 45° blades

The most famous professional cutter. Stainless steel holder with auto lock system.



Recommended knife blades: 120-AB10,
120-AB50, 120-AB10S, 120-AB50S, 120-ABB50

9
mm



Price per unit

OLFA® Professional Cutter **OLFA**

100-SAC-1



- For 30° blades

Stainless steel cutter with 30° angled blade for precision work. Without auto lock.



Recommended knife blades:
120-SAB-10, 120-BD100

9
mm

Price per unit



NT® Cutter **NT Cutter** EVER NEW & EVER SHARP

100-A300R



- For left and right hand users

Ergonomically designed cutter with special click system for gradually releasing blades.



QUICK TIPS

Recommended knife blades 120-AB10, 120-AB50, 120-AB10S, 120-AB50S, 120-ABB50, 120-BD100

9 mm



Price per unit

NT® Cutter - Metal Grip **NT Cutter** EVER NEW & EVER SHARP

100-A300GR



- For left and right hand users

Ergonomically designed cutter with special click system for gradually releasing blades. Metal grip.



QUICK TIPS

Recommended knife blades: 120-AB10, 120-AB50, 120-AB10S, 120-AB50S, 120-ABB50, 120-BD100

9 mm



Price per unit

OLFA® Auto - Lock Utility Knife with Blade Snapper **OLFA**

100-A-1



- For left and right hand users

The thin-model cutter, featuring a full-scale pocket-clip/blade snapper and carbon-like engraving on handle, fits hands and pockets perfectly. Thanks to its special fine control Auto-Lock slider, the sharp angle SAB/DKB blades are its official spare blades along with the standard AB/ABB blades. For both left- and right-handed users.



QUICK TIPS

Recommended knife blades: 120-AB10, 120-AB50, 120-AB10S, 120-AB50S, 120-ABB50, 120-BD100

9 mm

Price per unit

OLFA® A-2 Standard Duty Slide Lock Knife **OLFA**

100-A-2



- Anti-Slip

The non slip grip made of special rubber makes model A-2 easy to hold in the fingertips. To maximize handling ease and comfort. Comes with a pocket clip/blade snapper.



QUICK TIPS

Recommended knife blades: 120-AB10, 120-AB50, 120-AB10S, 120-AB50S, 120-ABB50, 120-BD100

9 mm

Price per unit

OLFA® Standard Duty Two Way Cutter **OLFA**

100-A-3



- Extra knife blade at the back

2-way standard duty cutter with multiple blade application.



QUICK TIPS

Recommended knife blades: 120-AB10, 120-AB50, 120-AB10S, 120-AB50S, 120-ABB50, 120-BD100

9 mm

Price per unit

OLFA® Standard - Duty Auto - Lock Cutter **OLFA****100-A-5****- One-way AutoLock mechanism**

The A-5 makes cutting safer with a revolutionary One-Way Blade Locking system, which firmly locks the blade in place for pulling in one-direction only. Equipped with an ExcelBlack blade, the A-5 is becoming popular worldwide because of its outstanding cutting performance. The handle has a very attractive contour, but more importantly you will be pleased with the comfortable grip and how it fits your hand.

**QUICK TIPS**

Recommended knife blades: 120-ABB50

9
mm

Price per unit

OLFA® Wheel - Lock Utility Knife **OLFA****100-300****- One-way AutoLock mechanism**

You can adjust this knife for custom cutting depths using its ratchet lock mechanism. The knife's slim, lightweight design makes it easy to use and easy to store in most pouches. The knife cuts through packaging, shrink wrap, vinyl, window , wallpaper, caulking, foam board and other materials.

Good For: Applications such as paint, window and packaging. Cuts tape, shrink wrap, wallpaper, , cardboard, caulking and more.

**QUICK TIPS**

Recommended knife blades: 120-AB10, 120-AB50, 120-AB10S, 120-AB50S, 120-ABB50, 120-BD100

9
mm

Price per unit

OLFA® ComfortGrip X - Design Series™ **OLFA****100-XA-1****- Auto lock; specially intended for Excel Blade snap-off blades.**

This blade holder combines sublime quality with design. The ergonomic form and the black anti-slip rubber instill a feeling of confidence during use. It is also resistant to chemicals. This blade holder has been specially developed for use with the special Excel Blades; these are thinner and much sharper than the standard snap-off blades.

**QUICK TIPS**

Recommended knife blades: 120-ABB50

9
mm

Price per unit

OLFA® Auto - Loading Auto - Lock Knife with Blade Storage **OLFA****100-PA-2****- Multi-Blade; Auto-Loading up to 5 blades**

Whether you need to cut packaging, shrink wrap, vinyl, window , wallpaper, caulking or foam board or similar materials, you are set with this knife. The knife holds up to five snap-off blades for your convenience. When a blade segment gets dull, simply snap it off and continue working.

Good For: Applications such as paint, window and packaging. Cuts tape, shrink wrap, wallpaper, , cardboard, caulking and more.

**QUICK TIPS**

Recommended knife blade: 120-AB10, 120-AB50, 120-AB10S, 120-AB50S, 120-ABB50, 120-BD100

9
mm

Price per unit



OLFA® SNAP IT 'N' TRAP IT™ Auto - Lock Utility Knife **OLFA**

100-DA-1



- Built-in blade snapper and disposal container

Give your knife blade a sharp new edge with just a snap. This innovative OLFA knife includes a built-in, detachable blade snapper that doubles as a disposable container. You'll find plenty of uses for this utility knife, from cutting packaging, shrink wrap and vinyl to window , wallpaper, caulking, foam board and more.



QUICK TIPS

Recommended knife blade: 120-AB10, 120-AB50, 120-AB10S, 120-AB50S, 120-ABB50, 120-BD100

9 mm

Price per unit

OLFA® Rubber Grip Auto - Lock Utility Knife **OLFA**

100-NA-1



- Acetone resistant

The rubber grip provides extra stability and control for this knife. It is not only sturdy, its handle is resistant to acetone. You'll appreciate the steadiness of the knife when you use it to cut packaging, shrink wrap, vinyl, window , wallpaper, caulking, foam board and other materials



QUICK TIPS

Recommended knife blade: 120-AB10, 120-AB50, 120-AB10S, 120-AB50S, 120-ABB50, 120-BD100

9 mm



Price per unit

OLFA® Standard Cutter Metal Body **OLFA**

100-180-BLACK



- Anti-slip

This multipurpose snap-off cutter is the modern version of the original snap-off cutter developed by OLFA Corporation in 1956. Ideal for light-duty cutting jobs. Features a positive slide lock with a handle that is designed for control and comfort, a pocket clip, and built-in blade snapper.



100-180-BT/36



QUICK TIPS

Recommended knife blades: 120-AB10, 120-AB50, 120-AB10S, 120-AB50S, 120-ABB50, 120-BD100

9 mm



100-180-BLACK
100-180-BT/36

1 piece
36 pieces in a plastic bucket

Price per pack
Price per pack

OLFA® S Cutter **OLFA**

100-S



- As simple as possible

A particularly inexpensive and compact model. Contemporary modern design with slimmer shaped metal handle. Includes yellow pocket clip/blade snapper.



QUICK TIPS

Recommended knife blades: 120-AB10, 120-AB50, 120-AB10S, 120-AB50S, 120-ABB50, 120-BD100

9 mm



Price per unit

OLFA® Economy Cutter Bucket - 40 pcs **OLFA**

100-SPC-1/40



- 40 pieces

Economy Knives with replaceable blade capability. 40 pieces in a plastic bucket. A pocket clip/blade snapper is included. This is a perfect Point of Purchase item for add on sales. (Uses standard size blades)



QUICK TIPS

Recommended knife blades: 120-AB10, 120-AB50, 120-AB10S, 120-AB50S, 120-ABB50, 120-BD100

9 mm



Price per unit



PROFESSIONNELS

12.5 mm

CUTTERS

OLFA® Cutter Ultra Sharp **OLFA**

100-FWP-1



- Thinner blade
Wallcovering cutter with a thinner and sharper blade.



QUICK TIPS

Recommended knife blade:
120-FWB-10, 120-FWB-50

12.5 mm

Price per unit

HEAVY DUTY

18 mm

KNIVES

NT® Heavy Duty Knife **NT Cutter** EVER NEW & EVER SHARP

100-L500GR



- With metal body
NT heavy duty knife with aluminum diecast grip and a special click system for gradually releasing blades. Perfect for cutting plastics, s, etc. This strong and sturdy knife is ideal for cutting large areas and strips of window s, wrapping s and interior s. The knife is stable and does not wobble while cutting. So you get nice straight cuts.

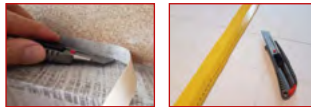

QUICK TIPS

Recommended knife blades:
120-LB10, 120-LB50

18 mm



Price per unit

OLFA® Heavy Duty Knife **OLFA**

100-L1



The most popular OLFA heavy duty knife. The body is solid and unbreakable. The perfect knife for cutting plastics, s, etc. This strong and sturdy knife is ideal for cutting large areas and strips of window s, wrapping s and interior s. The knife is stable and does not wobble while cutting. So you get nice straight cuts.



QUICK TIPS

Recommended knife blades:
120-LB10, 120-LB50

18 mm



Price per unit

OLFA® Rubber Inset Grip Ratchet - Lock Utility Knife **OLFA**

100-L2



If secure handling is important to you, you'll appreciate the anti-slip, ribbed rubber inset on this OLFA utility knife. The knife's pistol shape is designed to fit comfortably in your hand, and a finger stop provides added stability. Use this utility knife for construction materials including drywall, linoleum, carpet, flooring materials, insulation, and roofing materials. Good For: Applications such as flooring, drywall and roofing repair or replacement. Cuts carpeting, linoleum, drywall, roofing shingles and more.



QUICK TIPS

Recommended knife blades:
120-LB10, 120-LB50

18 mm

Price per unit



OLFA® 2 - Way Heavy - Duty Cutter with Blade Reapplication System **OLFA**

100-L3



- Extra knife blade at the back

2-way heavy duty cutter with multiple blade application. Professional strength stainless steel blade 18 channel secures blade for the toughest of cutting jobs.



Recommended knife blades:
120-LB10, 120-LB50

18
mm

Price per unit

OLFA® Rubber Grip Auto - Lock Utility Knife **OLFA**

100-NL-AL



- Acid and acetone resistant

A rubber grip provides extra stability and control for this knife. It is not only sturdy, its' handle is resistant to acetone. The knife has a slim shape that makes it easy to grasp and to fit in most pouches.

Good For: Applications such as flooring, drywall and roofing repair or replacement. Cuts carpeting, linoleum, drywall, roofing shingles and more.



Recommended knife blades:
120-LB10, 120-LB50

18
mm



Price per unit

OLFA® Rubber Grip Ratchet - Lock Utility Knife **OLFA**

100-NOL-1



- Anti-slip elastomer handle. Acid and acetone resistant

If you're working with paint, you don't have to worry about damaging this OLFA utility knife. Its' elastomer resin handle is chemically resistant to paint, paint thinner and MRO environments. The knife includes a stainless steel blade channel, ratchet wheel blade lock and stainless steel snap-off OLFA blade.



Recommended knife blades:
120-LB10, 120-LB50

18
mm



Price per unit

OLFA® Pro - Load' Multi - Blade Cutter and Auto - Lock **OLFA**

100-PL-1



- Up to 5 extra blades inside

Use this multi-blade OLFA utility knife, and you'll never be caught without an extra blade.

That's because you can store up to five extra blades in the automatic loading mechanism that can be operated with one hand.



Recommended knife blades:
120-LB10, 120-LB50

18
mm

Price per unit

OLFA® Slide Mechanism Utility Knife **OLFA**

100-SL-1



Easily change the cutting depth on this OLFA utility knife using just your thumb. The knife is preloaded with an eightsegmentblade, so you'll have to change the blade eight times less often! Use this utility knife for construction materials including drywall, linoleum, carpet, flooring materials, insulation, and roofing materials.

Good For: Applications such as flooring, drywall and roofing repair or replacement. Cuts carpeting, linoleum, drywall, roofing shingles and more.



Recommended knife blades:
120-LB10, 120-LB50

18
mm



Price per unit

OLFA® 90° Cutting Base Ratchet - Lock Utility Knife **OLFA**

100-CL



- With spacer and a built-in staple remover.

With its pistol grip, finger stop and ribbed contour, this OLFA utility knife gives you the control you need.

The snap-off blade has eight cutting edges to make every project quicker and more economical.

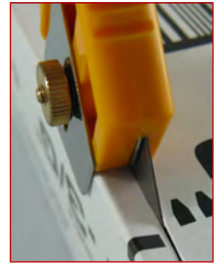

QUICK TIPS

Recommended knife blades:
120-LB10, 120-LB50

18
mm



Price per unit

OLFA® Extended Reach Ratchet - Lock Utility Knife **OLFA**

100-XL-2



- Extra long blade channel

When you want to put a little distance between your hand and what you're cutting, reach for this extended-length utility knife. The knife's blade channel extends the full length of the knife, providing the stability needed for the extra length.

Good For: Applications such as flooring, drywall and roofing repair or replacement. Cuts carpeting, linoleum, drywall, roofing shingles and more.



QUICK TIPS

Recommended knife blades:
120-LB10, 120-LB50

18
mm

Price per unit

OLFA® Economical Auto - Lock Utility Knife **OLFA**

100-EXL



- Single hand side lock mechanism

Economical Heavy-Duty Cutter with auto-locking blade.

Good for: Cutting paper, cardboard, roofing, drywall, vinyl, acetates, etc.



QUICK TIPS

Recommended knife blades:
120-LB10, 120-LB50

18
mm



Price per unit

OLFA® SNAP IT 'N' TRAP IT™ Auto - Lock Utility Knife **OLFA**

100-DL-1



- With intergrated disposal container

With this knife, you can remove dull blade edges easily and safely. Simply slide the blade disposal container off the knife, insert the dull blade into the end of the container and snap it off. The old blade disappears into the container, and a sharp new blade is ready for use. Good For: Applications such as flooring, drywall and roofing repair or replacement. Cuts carpeting, linoleum, drywall, roofing shingles and more.



QUICK TIPS

Recommended knife blades:
120-LB10, 120-LB50

18
mm



PAT

Price per unit



OLFA® Fiberglass - Reinforced Ratchet - Lock Utility Knife **OLFA**

100-L-5



OLFA X-design ComfortGrip series heavy-duty cutter. Sure grip handle made of elastomer and glass-fiber-reinforced polypropylene for acid and acetone (oil) resistant. Built-in hard metal pick for multi-purpose applications.



QUICK TIPS

Recommended knife blades:
120-LB10, 120-LB50

18
mm



Price per unit

OLFA® Fiberglass - Reinforced Ratchet - Lock Utility Knife **OLFA**

100-L-5-AL



Sure grip handle made of elastomer and glass-fiber-reinforced polypropylene for acid and acetone (oil) resistant. Built-in hard metal pick for multi-purpose applications.

Good For: Applications such as flooring, drywall and roofing repair or replacement. Cuts carpeting, linoleum, drywall, roofing shingles and more.



QUICK TIPS

Recommended knife blades:
120-LB10, 120-LB50

18
mm



Price per unit

OLFA® Metal Body Cutter with Auto - Lock **OLFA**

100-ML



- Black coated metal holder

Heavy-duty cutter with high grade black coated metal holder.

Assures you of top performance for all tough cutting jobs.

The auto-lock mechanism keeps the blade firmly in place.



QUICK TIPS

Recommended knife blades:
120-LB10, 120-LB50

18
mm

Price per unit



HEAVY DUTY

25 mm

KNIVES

OLFA® Fiberglass - Reinforced Auto - Lock Utility Knife **OLFA**

100-XH-AL



- You'll find countless excuses to use it

Good For: Applications such as general construction and industrial maintenance. Cuts leather, rubber, rope, fiberglass, acetates and more.



QUICK TIPS

Recommended knife blades: 120-HB-5B, 120-HB-20, 120-HBB-5B

25 mm



Price per unit

OLFA® Ratchet - Lock XHD Cutter **OLFA**

100-XH-1



- You'll find countless excuses to use it

With its pistol-shaped handle, this OLFA utility knife is a straight shooter when it comes to tough cutting jobs. Plus, the handle is chemically resistant to paint and MRO environments. Use this utility knife for cutting industrial materials such as gaskets, conduit, belt synthetics, rope, leather, laminates, plastics, fiberglass, rubber and textiles. Good for: Applications such as general construction and industrial maintenance. Cuts leather, rubber, rope, fiberglass, acetates and more.



QUICK TIPS

Recommended knife blades: 120-HB-5B, 120-HB-20, 120-HBB-5B

25 mm



Price per unit

OLFA® Rubber Grip Ratchet - Lock Utility Knife **OLFA**

100-NH-1



- You won't be able to resist this knife, with its chemical-resistant handle

And you won't believe how easy it is to use - one-hand blade changing and more - until you actually put it to use. This knife can cut industrial materials such as gaskets, conduit, belt synthetics, rope, leather, laminates, plastics, fiberglass, rubber and textiles.



QUICK TIPS

Recommended knife blades: 120-HB-5B, 120-HB-20, 120-HBB-5B

25 mm



PAT

Price per unit

OLFA® Rubber Inset Grip Ratchet - Lock Utility Knife **OLFA**

100-H-1



- Choose this rubber-grip OLFA utility knife when you want ultimate control

The knife has a symmetrical design, so it can be used by both right- and left-handers. Use this utility knife for cutting industrial materials such as gaskets, conduit, belt synthetics, rope, leather, laminates, plastics, fiberglass, rubber and textiles.

Good For: Applications such as general construction and industrial maintenance. Cuts leather, rubber, rope, fiberglass, acetates and more.



QUICK TIPS

Recommended knife blades: 120-HB-5B, 120-HB-20, 120-HBB-5B

25 mm

Price per unit



ROTARY 18 mm CUTTERS

OLFA® 18 mm Straight Handle Rotary Cutter **OLFA**

100-RTY-4



- 18 mm

This OLFA rotary cutter is a must for quilters and crafters. With its straight-handle, the cutter can be used by both rightand left-handed people. Use it to cut curved quilt pieces and templates, or to trim seams.

Good For: cutting small details or curves, applique or templates. Cuts fabric, rubber, paper, self-adhesive and more.



QUICK TIPS

Spare blade: 120-RB18-2



Price per unit

ROTARY 28 mm CUTTERS

OLFA® 28 mm Straight Handle Rotary Cutter **OLFA**

100-RTY-1/C



- 28 mm

28 mm Rotary Cutter is perfect for small-scale projects, miniatures and tight corners. This cutter features a durable handle with a blade cover for safety. The cutter is a rolling razor blade used to cut fabrics into shapes, strips and pieces for sewing, quilting and craft projects. The blade is made of high quality tungsten carbide tool steel for unparalleled sharpness and superior edge retention. Good For: cutting strips and multiple layers at once. Cuts fabric, rubber, paper, tarp, vinyl, upholstery and more.



QUICK TIPS

Spare blade: 120-RB28-2 and 120-RB28-10



Price per unit

OLFA® 28 mm Perforation Cutter **OLFA**

100-PRC-3/C



- 28 mm serrated blade
- Easy blade change

Perforation cutter from OLFA with a 28 mm serrated blade. Due to the larger (28 mm) diameter of the deeper serrated steel blade, perforations can be cut very easily. Suitable for making folds in cardboard, tear-off strips and serrated edges in paper and foil. The perforation blade is optionally replaceable by a regular 28 mm rotary cutter.

Made of high-quality Japanese tungsten tool steel and designed for unmatched sharpness and superior edge retention. All OLFA knives undergo an advanced manufacturing process where the micro-honed blade provides superior initial sharpness and edge retention, resulting in excellent sharpness and longevity.



QUICK TIPS

Spare blade: 120-RB28-2 and 120-RB28-10 (for straight cuts)



Price per unit

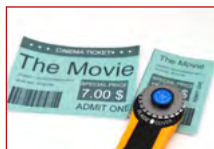

*suitable for cutting a range of materials like:
Fabrics, Textiles, cardboard, paper, Leather*



ROTARY

45 mm

CUTTERS

OLFA® Splash 45 mm Rotary Cutter **OLFA**

100-RTY-2/C



- Great for cutting thick and rigid s or sheets like security s etc.

There's no reason to struggle cutting through multiple layers; it's hard on the material and hard on you. This rotary cutter is ideal for medium to heavy-duty projects. It can accommodate up to six layers of thin materials.

Good For: cutting strips and multiple layers at once. Cuts fabric, latex and rubber sheets, paper, tarp, vinyl, upholstery and more.

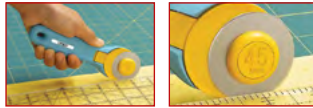

QUICK TIPS

Spare blade: 120-RB45-1

45 mm

Price per unit

OLFA® 45 mm Deluxe Handle Rotary Cutter **OLFA**

100-RTY-2/DX



- Great for cutting thick and rigid s or sheets like security s etc.

This rotary cutter is a combination of comfort, convenience, strength and safety. Its ergonomic handle with anti-slip rubber grip eliminates hand fatigue and stress, while the squeeze trigger allows the blade to self-retract for safety. The cutter can handle up to six layers of thin materials. And the quick blade change feature won't slow down your project.

Good For: cutting strips and multiple layers at once. Cuts fabric, paper, tarp, vinyl, upholstery and more.



QUICK TIPS

Spare blade: 120-RB45-1

45 mm



Price per unit

OLFA® 45 mm Straight Handle Rotary Cutter **OLFA**

100-RTY-2/G



- Great for cutting thick and rigid s or sheets like security s etc.

The most popular size available, this cutter features a durable handle with a blade cover for safety. The cutter is a rolling razor blade used to cut materials into shapes, strips and pieces for sewing, quilting and craft projects. The blade is made of high quality tungsten carbide tool steel for unparalleled sharpness and superior edge retention.

Good For: cutting strips and multiple layers at once. Cuts fabric, paper, tarp, vinyl, upholstery and more.



QUICK TIPS

Spare blade: 120-RB45-1 and 120-RB45-10

45 mm



Price per unit

OLFA® 45 mm Quick Change Rotary Cutter **OLFA**

100-RTY-2/NS



- Great for cutting thick and rigid s or sheets like security s etc.

The Quick-Change Rotary Cutter has an easy 45 mm blade change with just a single click. No more assembly with a washer and a nut. Just slide the locking mechanism and the blade immediately releases. The innovative split blade cover allows for switching hands effortlessly without reassembly and offers extra safety protection while cutting. Each side slides back and forth independently so the user can easily switch hands to cut. The blade is made of high quality tungsten carbide tool steel for unparalleled sharpness and superior edge retention.

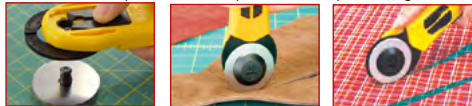

QUICK TIPS

Spare blade: 120-RB45-1

45 mm



Price per unit

ROTARY CUTTERS

60 mm



OLFA® 60 mm Deluxe Handle Rotary Cutter **OLFA**

100-RTY-3DX



- Safety locking system

OLFA's largest rotary cutter can cut up to eight layers of thin materials, making it perfect for medium- to large-sized projects and long cuts. Its curved handle, suitable for right- or left-handed use, prevents the fatigue typically associated with repetitive cutting. The dual-action safety lock and blade cover are designed to ensure your safety.

Good For: cutting strips, multiple layers and finishing quilts prior to binding. Cuts fabric, paper, tarp, vinyl, upholstery, leather and other thick textiles.



Spare blade: 120-RB60-1

60 mm



Price per unit

OLFA® 60 mm Straight Handle Rotary Cutter **OLFA**

100-RTY-3/G



- 60 mm

There's no reason to struggle cutting through multiple layers; it's hard on the material and hard on you. This OLFA rotary cutter is ideal for medium to heavy-duty projects. It can accommodate up to eight layers of material.

Good For: cutting strips, multiple layers and finishing quilts prior to binding. Cuts fabric, paper, tarp, vinyl, upholstery, leather and other thick textiles.



Spare blade: 120-RB60-1

60 mm



Price per unit

TOUCH KNIFE

10 mm

OLFA® Magnetic Touch Knife - 24 pcs **OLFA**

100-TK-3M



Magnetic Touch Knife features a stainless steel blade and magnetic back. Can be used for a number of purposes and easily fits in your pocket, purse, desk or glove compartment. "The handiest little knife in the world".

24 pcs. packed in a display card.



10 mm



Price per unit

OLFA® Multipurpose Touch Knife **OLFA**

100-TK-4



There's a reason we call this a multipurpose knife; you'll find innumerable uses for it. The compact knife can fit into your pocket, purse, desk drawer or glove compartment. Features include a blade lock for safety and a hanging hole that can slide onto your keychain. Use the knife for arts, graphics, crafts and hobby projects at home or in industry. The knife makes a great stocking stuffer or gift for any occasion.

10 mm

Price per unit

OLFA® Plastic - Laminate Cutter Heavy - Duty *OLFA***100-PC-L****- 2 Spare blades in handle; retractable function**

Score big - literally - with this cutter. In order to effectively cut sheet plastics and laminates, you first must score them. That's where this cutter comes in handy. Use it to score the material so you're assured a clean break.

Good For: Use in commercial and construction applications. Scores plastic, laminate and plexiglass.



Spare blade: 120-PB-800



Price per unit

OLFA® Heavy Duty Hook Cutter *OLFA***100-HOK-1**
- Retractable hook cutter
- Cuts thick plastic, vinyl, cardboard, rope, cloth, etc. without difficulty

Retractable hook cutter from OLFA. Cuts very easily through both soft and strong rigid materials. Ideal for not damaging surfaces or the inside of packaging. The hook knife can be fully retracted into the handle for complete safety. The high-quality carbon steel hook blade is hand sharpened to ensure a long and durable performance. Ideal for cutting thick vinyl, foils, carpet, linoleum, heavy vinyl sheets, cardboard, cloth, etc. The sliding wheel clamp can be positioned on either side for left or right-handed use.

Good For: Use in commercial and construction applications. Scores plastic, laminate and plexiglass.



Price per unit

OLFA® 45° Passe - Partout Cutter *OLFA***100-MC-45**
- Adjustable knife
- Perfect to use with the SOTT Yellow 5 non-slip ruler

Uniquely designed tool that takes all the work out of cutting beveled edges.

Perfect for cutting mount boards from cardboard at a 45° angle. The V-shaped blade slides easily to the left or right and is very sharp so that precise angles are cut.

COMES WITH 5 EXTRA KNIVES.

Recommended knife blades: 120MCB-1

Price per unit



OLFA® Compass Circle Cutter 1 to 15 cm **OLFA**

100-CMP-1

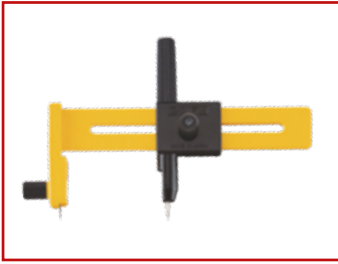

- Easy cutting perfects circles every time

Standard-duty circle cutter. Perfect for crafts, model making, photography and sign making. Cuts circles of 1 cm to 15 cm in diameter. Blades and spike covered by a safety case that contains 5 spare COB-1 blades and round rubber pad.



QUICK TIPS

Spare blade: 120-COB-1



Price per unit

OLFA® Ratchet Compass Circle Cutter 1.6 to 22 cm **OLFA**

100-CMP-1/DX

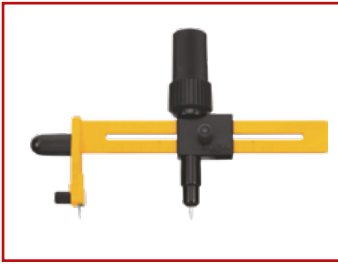

- Perfect circles every time

Standard-duty circle cutter easily and efficiently cuts clean, perfect circles from 1.6 cm to 22 cm in diameter. The ground-breaking patented ratchet mechanism reduces wrist fatigue. Designed for both right and left-handed. Includes a plastic guard to cover the pivot spike when not in use and round rubber pad. Comes with 10 extra COB-1 replacement blades in the package. Perfect for crafts, model making, photography and sign making.



QUICK TIPS

Spare blade: 120-COB-1



PAT

Price per unit

OLFA® Heavy - Duty Compass - Circle Cutter **OLFA**

100-CMP-2



- Perfect circles every time

Standard-duty circle cutter easily and efficiently cuts clean, perfect circles from 1.6 cm to 22 cm in diameter. The ground-breaking patented ratchet mechanism reduces wrist fatigue. Designed for both right and left-handed. Includes a plastic guard to cover the pivot spike when not in use and round rubber pad. Comes with 10 extra COB-1 replacement blades in the package. Perfect for crafts, model making, photography and sign making.



QUICK TIPS

Spare blade: 120-LB-10 and 120-LBB-10



Price per unit

OLFA® Rotary Circle Cutter 4 to 22 cm **OLFA**

100-CMP-3



- Easily make perfect circles and cuts multiple layers

The ground-breaking patented ratchet mechanism of the rotary circle cutter easily and efficiently cuts clean, perfect circles from 4 to 22 cm every time. Designed for both right and left-handed use and reduces wrist fatigue. Includes a built-in blade cover for safety, and a plastic guard to cover the pivot spike when not in use.

Uses RB18 replacement blades.



QUICK TIPS

Spare blade: 120-RB18-2



PAT

Price per unit

OLFA® Scissor - Stainless Steel Serrated Edge 5" - 127 mm *OLFA***100-SCS-1****- Short**

The extremely high quality stainless steel blades of this scissor is perfect for precise cutting. The serrated blades hold cutting objects tightly, grip the item being cut for accurate and powerful cutting. Accommodates both right- and left-handed users. Ideal for use on a variety materials such as paper, fabrics, plastic, rubber, etc.



Price per unit

OLFA® Scissor - Stainless Steel Serrated Edge 7" - 173 mm *OLFA***100-SCS-2****- Large**

The extremely high quality stainless steel blades of this scissor is perfect for precise cutting. The serrated blades hold cutting objects tightly, grip the item being cut for accurate and powerful cutting. Accommodates both right- and left-handed users.

Ideal for use on a variety materials such as paper, fabrics, plastic, rubber, etc.



Price per unit

OLFA® Quality Scissor - Stainless Steel 6.3" - 160 mm *OLFA***100-SCS-3****- High performance model**

This scissor has high quality stainless steel blades and is perfect for precise cutting. The serrated blades hold cutting objects tightly, grip the item being cut for accurate and powerful cutting. Accommodates both right- and left-handed users. Ideal for use on a variety materials such as paper, fabrics, plastic, rubber, etc.



Price per unit

OLFA® Precision Scissor - Professional Model 5.2" - 131 mm *OLFA***100-SCS-4**

- Precision Smooth Edge 5.2" (131 mm)
- Extra large handle for comfortable and precise cutting
- Precision scissors for perfect cutting of small details

Experience the convenience and high quality of these OLFA scissors. The extra large handle fits up to 3 fingers in one loop for more strength and comfort when cutting. The symmetrical handles are also suitable for both left and right handed users.

The straight edge blades glide easily through all types of and are sharpened to the point for smaller or application cuts.



OLFA's unique special sharpening process helps the blades grip into stiff, rigid, thick or tough s and cut cleanly without the material folding over the blades - even when cutting left-handed!

**THE PROFESSIONAL STAINLESS STEEL RIVET ENSURES
THAT THE BLADES ARE POSITIONED VERY ACCURATELY AND
CONTINUE TO MOVE SMOOTHLY, EVEN WITH HEAVY USE.**

Price per unit

SPARE BLADES

Stay sharp by refilling your cutting equipment with a wide range of blades, large and small. Make sure you always have quality blades on hand for uninterrupted work and precise, efficient cutting without damaging the glass.

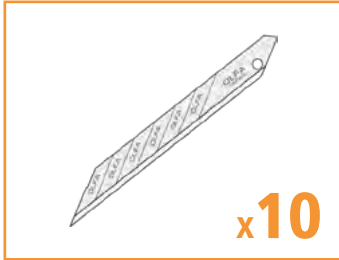

OLFA**9**
mm**30° BLADES****OLFA® 30° Snap - Off Graphics Blades - Super - Sharp** **OLFA****120-SAB-10**

- 10 Blade pack
- 7 Snap-off edges per blade

Standard-duty acute angle blade for use in a multitude of applications. This blade made from high quality carbon tool steel is produced using OLFA's precise multi-step production process for unparalleled sharpness and superior edge retention.

- ACUTE 30° ANGLE
- 7 SNAP-OFF EDGES PER BLADE

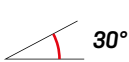
**9**
mm

120-ASB-10

10 blade pack

Price per pack

NT Cutter
EVER NEW & EVER SHARP**9**
mm**30° BLADES****NT® 30° Snap - Off Graphics Blades - Super - Sharp - 50 pack** **NT Cutter**
EVER NEW & EVER SHARP**120-BD-100A**

- 50 Blades per box
- 9 Snap-off edges per blade

Without doubt the sharpest 30° snap-off blades ever! Many professional fitters and designers prefer the 30° version to the standard 45° snap-off blades. The blades feel sharper and are far more versatile.

The sharp point is extremely handy for weeding and for pricking air bubbles during application.

- ACUTE 30° ANGLE
- 9 SNAP-OFF EDGES PER BLADE

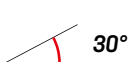
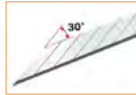
**9**
mm

Price per pack

SOTT**9**
mm**30° BLADES****SOTT® Ultra Black 30° Snap - Off Graphic Blades - 50 pack** **SOTT** **NEW****120-SUB-50**

- 50 Pieces in hardbox

Super-sharp honed, 30° snap-off blades with a black passivated top coat. This prevents corrosion and maintains the blades sharp for a longer period. The sharp 30° blade tip can also be used very well as an air release tool. Comes in convenient box of 50 pieces.

Fits all 9 mm blade holders from OLFA and NT.

**QUICK TIPS**

Perfectly combine with the following knifeholders:

**9**
mm

100-A300GR



100-A300R



100-SVR-2



100-SAC-1

Price per pack

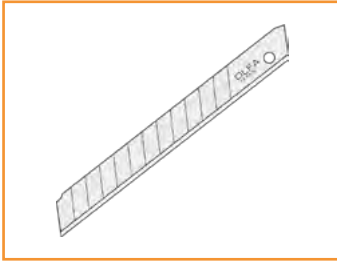
OLFA**9**
mm**59° BLADES****OLFA® 9 mm Silver Snap - Off Blades** **OLFA****120-AB SERIES****- High quality multi-use blade with superior edge retention**

Standard-duty, snap-off blade ideal for general crafts, cutting wallpaper, etc. The blade made from high quality carbon tool steel produced using OLFA precise multi-step production process for unparalleled sharpness and superior edge retention. Long lasting, durable snap-off blade - a new sharp edge with each snap. This 9 mm blade fits OLFA standard-duty knives. 13 cutting edges per blade.

- **MADE FROM HIGH-QUALITY CARBON TOOL STEEL**
- **DOUBLE-HONED BLADE PROVIDES SUPERIOR INITIAL SHARPNESS AND EDGE RETENTION**
- **EXACT 59° EDGE ANGLE OPTIMIZES CUTTING POWER AND MINIMIZES BLADE BREAKAGE**



120-ASB-10
120-AB-10
120-AB-50
120-AB-50B

10 standard-duty blades in a plastic case
10 blades in a plastic case with a blade disposal container
50 standard-duty blades in a plastic case
50 standard-duty blades, blister packed

Price per pack
Price per pack
Price per pack
Price per pack

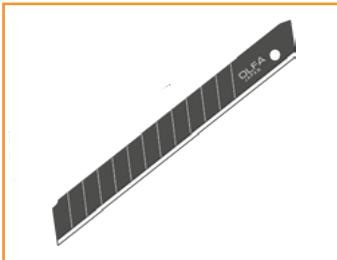
OLFA® 9 mm Black Ultra - Sharp Snap - Off Blades **OLFA****120-EXCELBLACK****- Ideal for applications requiring superior sharpness**

ExcelBlack ultra-sharp premium standard-duty snap-off black blades, exclusively designed for maximum cutting performance, are ideal for applications where superior sharpness is required. ABB blades made from high quality carbon tool steel are developed using a "special" double honing process for extreme sharpness and are 25 % sharper than standard-duty AB blades. Long lasting durable snap-off blade - a new sharp edge with each snap. 13 cutting edges per blade.

- **MADE FROM HIGH-QUALITY CARBON TOOL STEEL**
- **ULTRA-SHARP BLACK BLADE HAS A 25 % SHARPER EDGE FOR LESS CUTTING RESISTANCE**
- **EXACT 59° EDGE OPTIMIZES CUTTING POWER AND MINIMIZES BLADE BREAKAGE**
- **FITS OLFA PRO 9 MM UTILITY KNIVES**



120-ASBB-10
120-ABB-10B
120-ABB-50

10 Ultra-sharp blades in a plastic case
10 Ultra-sharp blades in plastic case with blade disposal container
50 Ultra-sharp blades in a plastic case

Price per pack
Price per pack
Price per pack

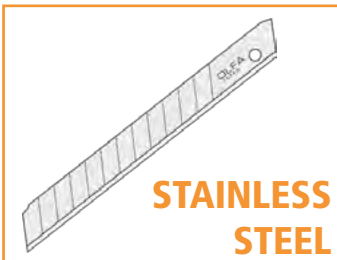
OLFA® 9 mm Stainless Steel Snap - Off Blades **OLFA****120-AB-S SERIES****STAINLESS
STEEL**

- **High quality stainless steel blade for use in moist environments**
- **Don't scratch on glass**

The blades ideal for use in moist environments (wallpapering, windows, etc.) where rust is a concern. This blade made from high quality steel is produced using OLFA precise multi-step production process for unparalleled sharpness and superior edge retention. Long lasting, durable snap-off blade - a new sharp edge with each snap. 13 cutting edges per blade.

- **MADE FROM STAINLESS STEEL**
- **DOUBLE-HONED BLADE PROVIDES SUPERIOR INITIAL SHARPNESS AND EDGE RETENTION**
- **EXACT 59° EDGE ANGLE OPTIMIZES CUTTING POWER AND MINIMIZES BLADE BREAKAGE**
- **FITS OLFA PRO 9MM UTILITY KNIVES**



120-AB-10S
120-AB-50S

10 ultra sharp medium size blades in a plastic case
50 ultra sharp medium size blades in a plastic case

Price per pack
Price per pack

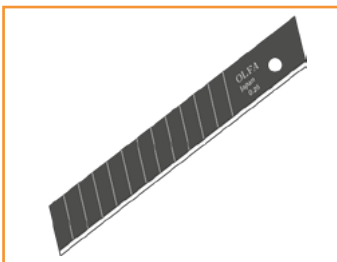
OLFA® EXCEL BLACK™ - Ultra Sharp 12.5 mm **OLFA****120-FWB SERIES**

- **Wallpaper cutting blades**
- **Super thin: 0.25 mm**

This OLFA EXCEL BLACK™ 12.5 mm blade is the only blade in the world developed specifically for cutting wallpaper. It has been designed with a unique 65° angle, which was researched to be the ideal angle for cutting paper against a wall, and getting into corners. The ultra thin (0.25 mm) blades will cut even the wettest, pasted wallpaper without dragging or tearing, and more importantly, leave near invisible joints. Splicing two layers of wallpaper is a pain with other blades, but these ones make it effortless, and leave results that impress. The blade has 13 snap segments.

- **SHARPEST POSSIBLE BLADE FOR CUTTING WALLPAPER**
- **ULTRA THIN FOR NEAR INVISIBLE JOINTS**
- **CUTS THROUGH WET, PASTED PAPER WITHOUT DRAGGING OR TEARING**

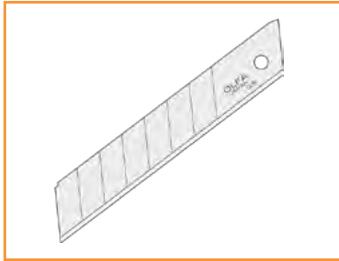

Price per pack

OLFA**18**
mm**59° BLADES****OLFA® 18 mm Silver Snap - Off Blades - Super - Sharp **OLFA******120-LB SERIES**

- Heavy-duty, snap-off blade; super sharp
- Stable and does not wobble during cutting

This blade made from high quality carbon tool steel is produced using OLFA's precise multi-step production process for unparalleled sharpness and superior edge retention. Long lasting durable snap-off blade - a new sharp edge with each snap. 8 cutting edges per blade.

- 8-SEGMENT PER BLADE
- 18 MM WIDE SNAP-OFF BLADE.
- MADE FROM HIGH-QUALITY CARBON TOOL STEEL
- DOUBLE-HONED BLADE PROVIDES SUPERIOR INITIAL SHARPNESS AND EDGE RETENTION
- EXACT 59° EDGE ANGLE OPTIMIZES CUTTING POWER AND MINIMIZES BLADE BREAKAGE



120-LB-10
120-LB-10B
120-LB-50
120-LB-50B

1 blades in plastic case
10 blades in plastic case
50 blades in plastic case
50 blades in plastic case

Price per pack
Price per pack
Price per pack
Price per pack

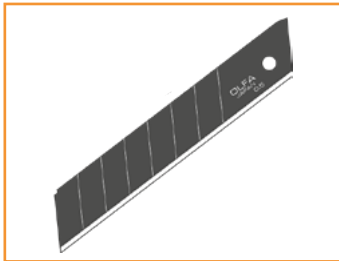
OLFA® 18 mm Excel Black™ - Ultra Sharp **OLFA****120-LBB SERIES**

- Black means ultra sharp

ExcelBlack ultra-sharp premium heavy-duty snap-off black blades, exclusively designed for maximum cutting performance, are ideal for applications where superior sharpness is required. LBB blades made from high quality carbon tool steel are developed using a special double honing process for extreme sharpness and are 25 % sharper than Heavy-Duty LB blades. 8 cutting edges per blade.

- MADE FROM HIGH-QUALITY CARBON TOOL STEEL
- EXACT 59° EDGE ANGLE OPTIMIZES CUTTING POWER AND MINIMIZES BLADE BREAKAGE
- FITS OLFA PRO 18 MM UTILITY KNIVES



120-LBB-10
120-LBB-50

10 blades in plastic case
50 blades in plastic case

Price per pack
Price per pack

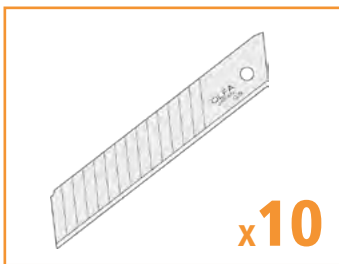
OLFA® 18 mm Double Segments - Heavy - Duty **OLFA****120-LBD-10**

- 15 Snap-off edges per blade!

Heavy-duty, snap-off blade ideal for construction and industrial applications. This blade made from high quality carbon tool steel is produced using OLFA's precise multi-step production process for unparalleled sharpness and superior edge retention. Long lasting durable snap-off blade - a new sharp edge with each snap.

x10

Price per pack

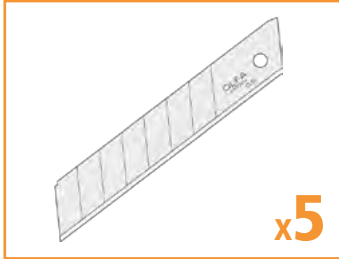
OLFA**25**
mm**59° BLADES****OLFA® 25 mm Silver Snap - Off Blades - 5 Pack **OLFA******120-HB-5B**

Extra-heavy-duty, snap-off blade for the toughest jobs. This blade made from high quality carbon tool steel is produced using OLFA's precise multi-step production process for unparalleled sharpness and superior edge retention.

This 25 mm blade fits OLFA extra heavy-duty utility knives. 7 cutting edges per blade.

Packing: HB-5B contains 5 blades in a plastic case, blister packed.

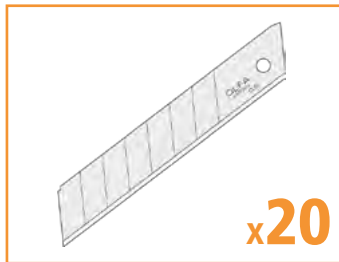
*Price per pack***OLFA® 25 mm Silver Snap - Off Blades - 20 Pack **OLFA******120-HB-20**

Extra-heavy-duty, snap-off blade for the toughest jobs. This blade made from high quality carbon tool steel is produced using OLFA's precise multi-step production process for unparalleled sharpness and superior edge retention.

This 25 mm blade fits OLFA extra heavy-duty utility knives. 7 cutting edges per blade.

Packing: HB-5B contains 20 blades in a plastic case.

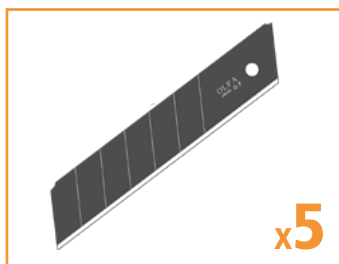
*Price per pack***OLFA® 25 mm Excel Black™ Blades - Ultra - Sharp **OLFA******120-HBB-5B**

ExcelBlack ultra-sharp premium extra heavy-duty snap-off black blades, exclusively designed for maximum cutting performance, are ideal for application where superior sharpness is required. HBB blades made from high quality carbon tool steel are developed using a special double honing process for extreme sharpness and are 25 % sharper than extra heavy-duty HB blades. Long lasting durable snap-off blade-a new sharp edge with each snap. 7 cutting edges per blade.

Packing: HBB-5B contains 5 blades in a plastic case, blister packed.

*Price per pack*

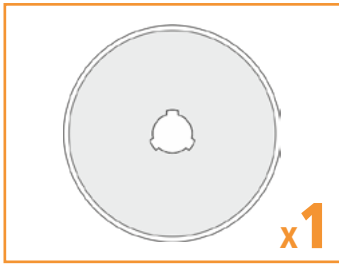
OLFA® 60 mm Tungsten Tool Steel Rotary Blade **120-RB60-1**

These replacement blades are designed for OLFA rotary cutters. Made of tungsten tool steel, these blades offer unparalle sharpness and superior edge retention.

Good For: cutting curves, sewing patterns and general cutting.

Cuts fabric, paper, and more.

Fits OLFA cutter RTY-3/DX, 3G.

60
mm

Price per unit

OLFA® 45 mm Circular Pinking Blade - Stainless Steel **120-PIB45-1**

This circular OLFA rotary replacement pinking blade is designed to place "teeth" on the edge of fabric to reduce raveling and to add a unique edge to any project. Very popular with crafts and memory book development. Also great for use with Polar

Fleece! This blade is made of stainless steel for sharpness and durability. 1 blade per pack.

For use only with the OLFA 45 mm deluxe rotary cutter 100-RTY-2/DX.

45
mm

Price per unit

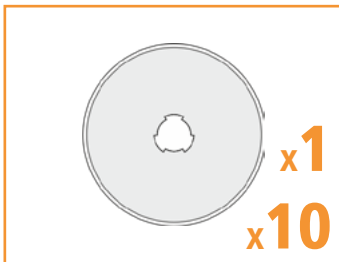
OLFA® 45 mm Tungsten Tool Steel Rotary Blade - Available in 1 or 10 pack**120-RB45 SERIES**

These replacement blades are designed for OLFA rotary cutters. Made of tungsten tool steel, these blades offer unparalle sharpness and superior edge retention.

Good For: cutting curves, sewing patterns and general cutting.

Cuts fabric, paper, and more. Fits the original 45 mm rotary cutter (RTY-/DX, 2NS, 2G, 2C).

45
mm

120-RB45-1
120-RB45-10

1 blade in plastic case
10 blades in plastic case

Price per pack
Price per pack

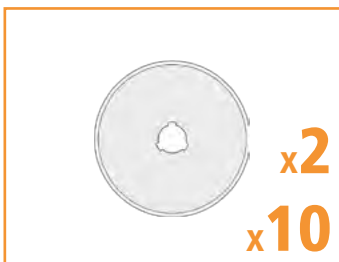
OLFA® 28 mm Tungsten Tool Steel Rotary Blade - Available in 2 or 5 pack**120-RB28 SERIES**

These replacement blades are designed for OLFA rotary cutters. Made of tungsten tool steel, these blades offer unparalle sharpness and superior edge retention.

Good For: cutting curves, sewing patterns and general cutting.

Cuts fabric, paper, and more. Fits the original 28 mm rotary cutter (RTY-1/G).

28
mm

120-RB28-2
120-RB28-10

2 blades in plastic case
10 blades in plastic case

Price per pack
Price per pack

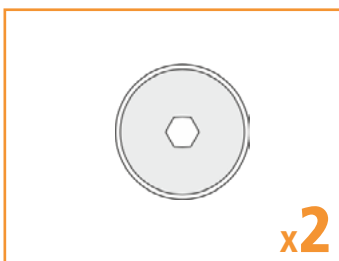
OLFA® 18 mm Tungsten Tool Steel Rotary Blade **120-RB18-2**

These replacement blades are designed for OLFA rotary cutters. Made of tungsten tool steel, these blades offer unparalle sharpness and superior edge retention.

Good For: cutting curves, sewing patterns and general cutting.

Cuts fabric, paper, and more. Fits the original 18 mm rotary cutter (RTY-4).

18
mm

Price per pack

OLFA® Stainless Steel Scraper Blades - for OLFA® Glass Scrapers **OLFA**

120-GSB-1S

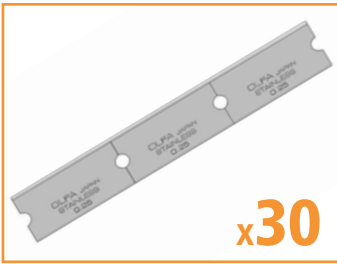

x30

- Pack of 30 blades
- Sharpened on both sides
- 120 mm x 0,25 mm
- Also fits small scraper 300-GSR-2 (snap off system)

Stainless steel blade for the wide glass scraper 300-GSR-1 and the mini glass scraper 300-GSR-2. The special thing is that the knife consists of 3 segments that can be broken off from each other. So all of a sudden you have 3 blades for the mini scraper! Specifically designed for the toughest scraping jobs without scratching the glass surface. Double ground cutting edge for superior sharpness and durability. Removes with ease: paint, vinyl, silicone, glue, dirt from ceramic or glass cooktops, s and s, stickers, paint residue, varnish, all types of sealants, mortar, excess adhesives and grout, etc.



Specially for OLFA scrapers:



300-GSR-1



300-GSR-2

Price per pack

OLFA® Blade - for OLFA 300 - GSR - 2 Glass Scrapers **OLFA**

120-GSB-2S



x20

- 6 Blades in box
- Stainless steel

Stainless steel blades for the OLFA 300-GSR-2. Made of tungsten steel for outstanding sharpness.



Specially for OLFA scrapers:



300-GSR-2

Price per pack

OLFA® 100 mm Scraper Blades - 0.8 mm thick - 6 pack **OLFA**

120-BS-08/6B



x6

Extra heavy duty and thick blade (0.8 mm) for OLFA scraper made of carbon tool. The blades fit all extra-heavy-duty XSR scrapers.



Specially for OLFA scrapers:



300-050, 300-051, 300-052

Price per pack

OLFA® 100 mm Dual - Edge Scraper Blades - 10 pack **OLFA**

120-BS-10B



x10

Some jobs call for a sharp-edged scraper and some for a rough-edged scraper. These scraper blades give you both. All jobs call for a durable blade, and that's what you get with these carbon tool steel blades. The blades fit all extra-heavy-duty XSR and BSR scrapers.



Specially for OLFA scrapers:



300-050, 300-051, 300-052

Price per pack

OLFA® 100 mm Flexible Dual - Edge Scraper Blades - 0.45 mm thick - 6 pack

120-BSF-6B

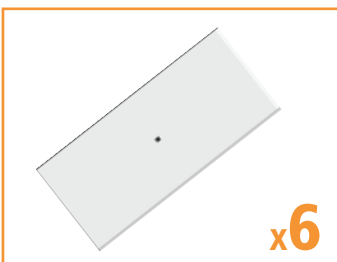

x6

Made of carbon tool steel for durability and designed with both a sharp and rough edged side. Thick (.45 mm) but flexible blade allows for better leverage on difficult materials. 100 mm flexible blade for all BSR and XSR Scrapers.



Specially for OLFA scrapers:



300-050, 300-051, 300-052

Price per pack

OLFA® Chisel Blades - for OLFA 100 - AK - 4 **120-KB4-F****- 5 Blades**

OLFA chisel blades for the professional Art Knife 100-AK-4. Packaged in a plastic box.



Specially for OLFA knife:



Price per pack

OLFA® Curved Blades - for OLFA 100 - AK - 4 **120-KB4-R****- 5 Blades**

OLFA curved cutting blades for the professional Art Knife 100-AK-4. Packaged in a plastic box.



Specially for OLFA knife:



Price per pack

OLFA® Precision Blades - type #11 **120-KB4-S****- 5 Blades in box
- 23° Cutting angle**

This OLFA precision knife is the type most used worldwide in applications where precise cuts are required. The knife has a 23° tip and is made of high-quality carbon tool steel. It is produced using OLFA's precise multi-step manufacturing process for unmatched sharpness and superior edge retention. These blades are good for trimming and deburring plastics, wood, s and more.



Fits in these knives:



Price per pack

X - ACTO® Blades **120-KB4-S****- Pack of 100 blades**

Blades for the well known X-Acto art knife 100-003, 100-004, and OLFA 100-AK-4.



Fits in these knives:

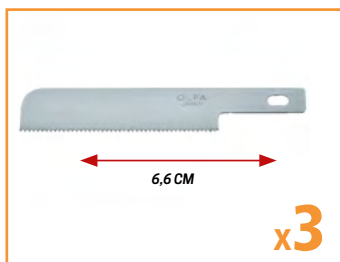

Price per pack

OLFA® Mini Saw Blades **120-KB4-WS****- Pack of 100 blades**

This OLFA mini saw blade is designed for making straight cuts in wood and plastic. Perfect for model making, crafting, hobby, and more. Made of high-quality carbon tool steel and designed for unmatched sharpness and superior edge retention.

3 blades per package.



Specially for OLFA knife:



Price per pack

OLFA® Knives + Needle **120-KB-5/30B**

This OLFA set includes 30 razor sharp blades with 30° point for precision cuts. Also included is one sharp needle. Both are made of high carbon tool steel and designed for unmatched sharpness and superior edge retention.



Fits in these knives:



Price per pack

OLFA® Multipurpose Blades - Pack of 25 *OLFA***120-KB-25**

OLFA Art Knife Blade KB is a general purpose art hobby blade. Fits OLFA AK-1 and AK-4 art knives.

Price per pack

OLFA® Top Sheet Cutter Blades - 5 Pack *OLFA***120-TSB-1**

Top Sheet Cutter replacement blade fits the OLFA Top Sheet Cutter (TS-1). Made from high quality carbon tool steel.

Price per pack

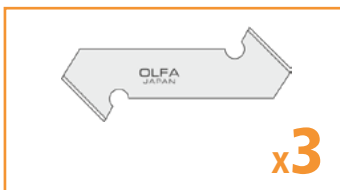
OLFA® Plastic - Laminate Blades - 3 pack *OLFA***120-PB-800**

3 blades for heavy-duty plastic/laminate cutter PC-L in a plastic case. Packed in a plastic box.

Price per pack

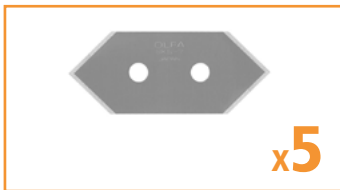
OLFA® Spare Blade - for OLFA 45° Cutter *OLFA***120-MCB-1**

These OLFA spare blades are for the OLFA master-key cutter (100-MC-45). Made of high-quality tungsten steel. Can be used on both sides.

Price per pack

OLFA® SPARE BLADE - for OLFA 45° Cutter *OLFA***120-PB450**

We call it a set of five, but actually you have 10!

That's because each blade in this pack has two razor-sharp cutting edges. The blades are made of tungsten steel and are ideal for medium duty work. Replacement blades for the OLFA PC-S laminate cutter.

Price per pack

Spare Blades for SOTT® Backing Cutter *SOTT***120-023R**

- 10 Blades in carton

Spare blades for SOTT backing Slitter.



Specially for Backing Cutter:



120-023

100-026

Price per pack

Spare Blades for EEZ Reach Cutter *NEW***120-LH70R**

- 10 Blades in carton



Specially for EEZ Reach Cutter:



100-LH70

Price per pack

Razorblades - Single Edge

300-004



- Width: 25.4mm

Very sharp blades (razorblades) for use in metal razorblade scraper 300-003 or in extended grip 300-005. One-sided edge. Per 100 pcs.



Fits in:



Price per pack

Refills 25 Blades Super Sharp

300-002

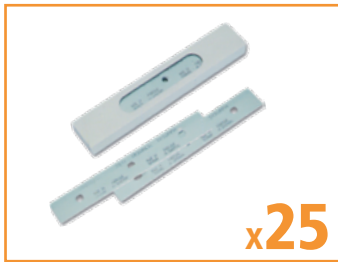

- Super sharp
- Double sided
- 15 cm wide

Box of 25 double-sided blades



Fits in:



Price per pack

Refills 25 Blades Stainless Steel

300-015R



- Super sharp
- Double sided
- 15 cm wide

Box of 25 double-sided blades



Fits in:



Price per pack

NT® Cutter Scraper Replacement Blade **NT Cutter**

300-BSC-21P



- 2 Blades
- Heavy duty interchangeable blade for NT Scraper 300-SC5P.
- Highly corrosion-resistant stainless steel blade.

Blade width: 60 mm, thickness: 1.0 mm

For removing dirt and paint from walls and floors.



Fits in:



Price per pack

BLADE DISPOSAL CONTAINERS

SOTT® Snap - Off Blade Container **SOTT**

120-DB



- 25 mm Slot

This handy knife container is a must for any workshop. Simply and safely slide all old and used blades into this container. The container can be opened at the bottom to empty it. Store the container on your cutting table, in your Toolbox or in your Toolbag.

Another fact: the SOTT Tool bag (400-016S or 400-016LB) has a special pocket at the back to place the knife container. This way you always have a safe option within reach to store your used knife blades.



Price per unit

OLFA® Safety Blade Disposal Unit **OLFA**

120-DC-2



- Safely and easily dispose of used blades

The deluxe DC-2 blade disposal case features a metal slot to easily snap off extra heavy-duty HB blade. The lid can be opened and DC-2 can safely hold even 60mm rotary blades. The stored blades can be discarded separately and reused. Good for use at quilt working site.



Price per unit

OLFA® Safety Blade Disposal Can **OLFA**

120-DC-3



- For 9 & 18 mm snap-off blades

Enjoy one-touch blade disposal while working on projects. This OLFA blade disposal can has a tambour door that's secure enough to stay shut, convenient enough to open when you're ready to use it. The pocket-sized can fits into a desk drawer, toolbox or workstation and is perfect for construction and industrial worksites, garages and sign shops.

Convenient canister design.



Price per unit

OLFA® Safety Blade Disposal Case **OLFA**

120-DC-4



- With loop hole for handy hanging

Safely dispose of used blades with this convenient blade case. Screw safe system prevents blades from falling out accidentally. Press-release operating system to ensure the blade slot is only exposed when in use. Loop hole and peg hole for hanging.

Easily fits in a back pocket, toolbox, or workstation, reusable.

Price per unit

OLFA® Blade Disposal Holster **OLFA**

120-DC-5



- Insert - snap off - get a fresh edge

Designed for quality-conscious professionals who snap off most frequently. The Blade Disposal Holster DC-5 features easy blade snapping in 2 blade positions and stores used segments while clipping on a tool bag, or a belt. Its compact size is perfect to carry around for one work day. Dispose used segments in bulk at the end of the day!



Price per unit



OLFA

BLADE REPLACEMENT

SCRAPING & CLEANING

Prepare the surface of your windows before applying the adhesive with our selection of scraping and cleaning tools. Remove glue, paint and dirt residue with our professional scrapers and cloths.



Roll Dispenser

500-050



- Indispensable in every workshop

Metal dispenser for rolls of triple layer polishing paper (300-040). This handy dispenser holds a roll of polishing paper and allows individual sheets to be torn off across a black perforated guide at the top. The dispenser can be folded for easy transportation.



QUICK TIPS

Suitable for:



300-040

Price per unit

SOTT® Polishing Paper - Triple Layer

300-040

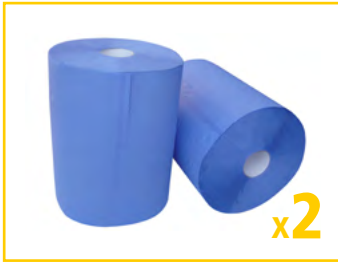

- 2 Rolls -37 cm (1'3") wide

Industrial grade triple layer highly absorbent polishing paper. This paper is extremely strong and will not disintegrate when saturated with water. Soft but strong. Indispensable in every workshop.



This high quality compactly rolled polishing paper is extremely soft and so will not scratch the substrate.



QUICK TIPS

Suitable for:



500-050

Price per pack

Lowtack Tack Rags - On a Roll

300-023



- Removes all dust from any surface - Leaves no residue

Slightly adhesive wipe on a roll. Ideal for removing all dust from any surfaces to be worked on. Removes dust from prints before laminating. Removes dust from windows and bodywork prior to application. Removes dust from metal surfaces before painting or spraying. The roll is 30 cm (1'2") wide and each roll consists of individual sheets that can be pulled off as required.

One side is slightly adhesive. Leaves no residue.



QUICK TIPS

Roll length: 36 m (62 sheets)



LowTack tack rags on a roll are the perfect solution for removing dust from a variety of surfaces. Individual perforated sheets.

Price per unit

Tack Cloth Dust - Fix

300-022



- 10 Pack

Slightly sticky cloth. Perfect for removing dirt and dust of window frames, cars or any area which has to be dust and dirt free before applying signs. Will not leave any residue behind. Creates an anti-static surface.

Price per pack

SOTT® Premium Microfiber Cloth - pack 5 pcs **NEW** SOTT

300-029



x5

- Premium Microfiber 40 x 40 cm
- 500gr fine-textured
- 5 pieces in bag

Proper cleaning is essential for assembly. Microfibre cloths are then indispensable. But which one is suitable?

This copper premium microfibre cloth immediately stands out from the competition when held in hand. The cloth's minuscule wavy structure scoops dirt from the surface, as it were, while moisture stays in the cloth. This combination ensures optimal cleaning.

Also, its smaller structure provides more coverage on the surface, so that every mm is cleaned.



QUICK TIPS

40 x 40 cm

Price per pack

LaPal Microfiber Cloth - Eco Sustainable - pack 5 pcs **NEW**

300-045



x5

- Made of recycled material
- 5 Pieces in box

These LaPal microfibre cloths (including packaging) are made of recycled material to reduce environmental impact. Thus, the cardboard packaging contains 5 pieces of microfibre cloths produced from 80% recycled polyester and 20% polyamide.

Not wanting to use unnecessary colour processes, the cloths are neutral white. This is also advantageous to the sign maker, window tinter, car wrapper and ppf installer. As a result, dirt residues are easily visible on the cloth when cleaning.



QUICK TIPS

The LaPal set consists of 5 cloths, each measuring 40 x 40 cm.



Beautifully stitched edges prevent lint



Produced from recycled material



5 pieces in box

Price per unit

Car Dash Cover - 76 x 180 cm **NEW**

300-032



- XXL microfiber cloth

Whether you are installing or removing a window, there is always a massive quantity of water around. Thanks to this XXL microfiber cloth, you can now cover and protect large areas such as dashes, or even in residential areas in which wood finishes would be endangered by water. It's also very useful for car wrapping or ppf installation, where you want to save time on drying the body paint after a quick detailing/cleaning.



Price per unit



QUICK TIPS

76 x 180 cm.

SOTT® Deep Cleaning Clay **NEW** SOTT

300-049



- Kneadable clay for deep cleaning of car paintwork
- For use on car paintwork, glass, hard plastic, mirrors and metals

Anyone who thinks that car paintwork is really clean after washing and degreasing with a good cleaner will be disappointed. Bird droppings, tree sap, tar, road grime and fallout affect the paint and soak into the open structure of the paintwork. Thorough cleaning is then needed. This kneadable clay is made from petroleum resin to which a mild abrasive has been added. This breaks down stubborn dirt, which degreasers and cleaners cannot do.

Microscopically, car paint has an open structure in which dirt settles. This cannot be removed with regular agents or even a steam cleaner. SOTT Deep Cleaning CLAY is therefore an indispensable product for non-porous surfaces where self-adhesive must adhere exceptionally well. These include edges, deep indentations and kinks. SOTT Deep Cleaning CLAY is used with water.



QUICK TIPS

Note: the colour of the clay may vary, but does not affect the quality

Price per p/set

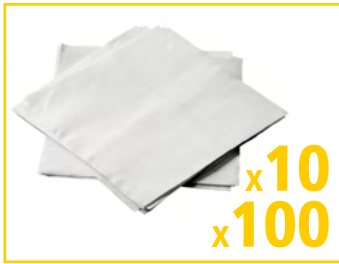

- Highly moisture absorbent, dust and lint free; won't tear
- Ideal for cleaning joints and other nooks and crannies.
- Indispensable for fitters and car wrappers

Ultra Clean white polishing cloths, often called surgical cloths, are manufactured from a micro fibre material and are completely lint and dust free. Not one single fibre is released during polishing. This enables the perfect cleaning of any surface. Extremely high moisture absorbency.

The all-round professional

Ultra Clean is so versatile it can truly be called an all-round professional. It can be used for cleaning electrical components, printer heads on industrial printing equipment, cleaning and degreasing windows and windscreens before the application of . Also ideal for cleaning acrylate and rigid foam sheets, as well as for cleaning cars and other vehicles before applying .

Inspection cloth: Ideal!

These cloths are also highly suited for cleaning and degreasing hard to access areas such as in gaps and joints on cars and other vehicles.

The perfect cloth for CLEANING and INSPECTION purposes

FOR CLEANING:

- PRINT HEAD STATIONS
- PRINTER COMPONENTS
- ELECTRICAL COMPONENTS
- ACRYLATE
- RIGID FOAM
- VULNERABLE SURFACES
- BISONYL
- PAINTED AND UN-PAINTED CARS
- GLASS WINDOWS AND FACADES
- DOOR SEALS AND FRAMES
- WINDSCREENS, INCLUDING THE DOT MATRIX



The amount of stubborn dirt that these cloths can still remove from joints, edges and gasps is simply amazing.



Good application is dependent on good adhesion. That goes without saying. Unfortunately, the cleaning and degreasing of the most critical areas get overlooked. These include joints, sills and gaps in bodywork. This is exactly where the tends to come loose and curl.

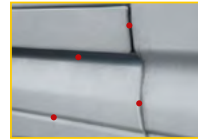

Experience has taught us that these are critical places that are often overlooked during cleaning. That's just not possible when Ultra Clean cloths are used. If necessary, just wrap a cloth around one of our special squeegees. Apply a little SOTT Surface Cleaner-II (600-SC02) or Industrial Degreaser (600-T800) to the cloth and get in to those nooks and crannies. The cloth will absorb the dirt which will be visible on the cloth itself. Only when the cloth stops absorbing dirt is the surface clean enough for the application of .

Ultra Clean cloths are available in packs of 10 or 100.



Thorough cleaning of any joints or other awkward areas is essential for good adhesion.



Simply take a squeegee and wrap a cloth around it. This will make the cleaning and degreasing of these hard-to-access areas a lot easier.



Ultra Clean cloths area ideal for checking to see if you have cleaned and degreased properly. These perfectly white cloths will soon show if any dirt is left in those awkward corners before you start application.



QUICK TIPS

Simply take a squeegee and wrap a cloth around it, this will allow you to clean and check all of those hard to access areas.

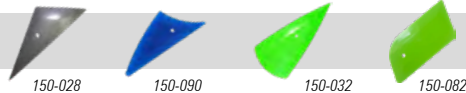

300-021
300-020

price per package of 10 pieces
price per package of 100 pieces

Price per pack
Price per pack

Scotchbrite® Non - Scratch Scrub Sponge 3M

300-363



- Grooved holder for perfect grip
- 15 x 7 x 4,5 cm

Very special, non-scratch scrub sponge . Perfectly cleaning any surface you want. Will not scratch the surface when the sponge is wet. Ideal for cleaning shop windows, glass, plastics etc. And it removes adhesive residues too!
The grooved holder improves the grip on the sponge.

Price per unit

Scotchbrite® Scrub Pad - Thin 3M

300-026

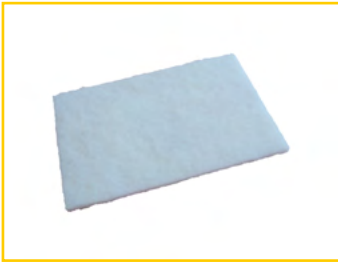

- 22,5 x 15,5 x 1 cm

Pro quality scourer Thin edition. Works very well for the removal of tough dirt and little bumps on car and home windows. The sponge is less than half an inch thick and fits nicely on the 300-035 SCRUBBER, so you can reach far corners and other hard-to-reach spots.



QUICK TIPS

Also useable on the: SCRUBBER scrub pad squeegee



300-035

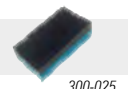

300-026

Price per unit

Scotchbrite® Scrub Pad - Thick 3M

300-027



- 25,5 x 12 x 2,5 cm

Large scrub pad for glass cleaning. Easy to use because of its size. Useful for the thorough cleaning of the »dot matrix« on car windows.



QUICK TIPS

Also useable on the: SCRUBBER scrub pad squeegee



300-035



300-027

Price per unit

Copper Wipes - for Improved Adhesion to the Dot Matrix 3M

300-028



- Soft and fine structure

Special copper wipes for cleaning the dot matrix, often seen around the edge of windcreens. It is often quite difficult to get to adhere between the dots. These copper wipes will polish the raster slightly and this will improve adhesion. Copper wipes should only be used on the dot matrix.



QUICK TIPS

CAUTION: NOT useable on tempered glass

Price per unit

Cleaning Sponge For Textured Surfaces - Absorbs Dirt 3M

300-044



- Extracts dirt from the pores
- Perfect for matte car wrap s
- Perfect for textured interior s

This special white sponge, in combination with our Car Wrap Cleaner 600-CC44 cleaning spray is the perfect solution for cleaning matte self adhesive s like car wrap * (especially matt). The sponge extracts all dirt released from imperfections in the , returning it to its original colour. Rinse the with water and job done!

NB: these sponges should not be compared with other conventional sponges as they are more susceptible to wear and tear. Copper wipes should only be used on the dot matrix.



QUICK TIPS

For best result, use:



600-CC44

*A detailed explanation of this process is included in Car Wrap Cleaner product 600-CC44.

Price per pack

The Scrubber Scouring Pad Squeegee

300-035

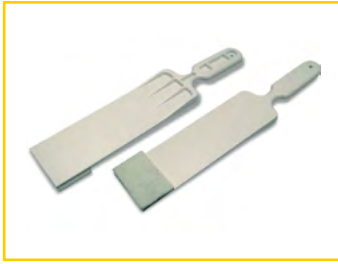

Before is applied the glass should be clean, degreased, and any hard specks of dust or dirt should be removed. However, it's not always easy to get to every part of the window. Perhaps the window is just too big, or perhaps you can't get behind a radiator or a cabinet, etc.

It's now a piece of cake! Just attach a scouring pad (see 300-026) to the Velcro on the SCRUBBER and use where necessary. The SCRUBBER is made of sturdy plastic allowing a good deal of pressure to be applied during cleaning.



Use on this squeegee:

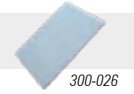

The SCRUBBER is equipped with a strip of Velcro allowing the simple attachment of a scouring pad.

Price per unit

Cleaning Squeegee

150-113



- For proper cleaning of the edges of window frames.
- 10 cm

Special squeegee for cleaning the edges of the glass at the window frame. The rubber is stiffer than ordinary squeegees and therefore the dirt can be pushed away better with the water.



See them page:

150-113
150-112
150-111
150-110

10 cm
17 cm
23 cm
77 cm

Price per unit
Price per unit
Price per unit
Price per unit

Lil' Chizler

150-033



Small and thin squeegee for small areas like the triangular windows, or for squeezing small air bubbles away. Also perfect to remove dirt and old adhesives from the rear window. Will not damage defrost liners on the rear window.



Price per unit

The Chizler - Standard

150-034



Bigger than his little brother shown above. Will not damage defrost liners on the rear window.

Price per unit

Gator Blade I - Red

300-016



Meet the ultimate plastic scraper. Our Gator Blade is as sharp as they come, but won't scratch or damage the glass. Safer and easier to use than razors, the Gator Blade is fast becoming the choice of installers, applicators and detailers everywhere. Perfect for cleaning glass, removing excess adhesive to scraping off decals.

Price per unit

Triumph MK II - Super Scraper

300-001



- For flat glass
- 15 cm wide

Wide scraper with a very thin but robust scraper blade. Includes safety cover. A rubber wiper is fitted to the cover. The paper thin steel scraper blade is double edged. Refillable.



QUICK TIPS

REFILLS: Super Sharp
Box with 25 double-sided blades.

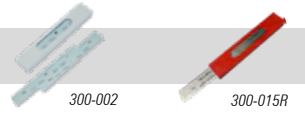

Price per unit

Triumph MK III - Angled Super Scraper

300-015



- For flat glass
- 15 cm wide

Wide scraper with a very thin but robust scraper blade. Includes safety cover. A rubber wiper is fitted to the cover. The paper thin steel scraper blade is double edged. Refillable.



QUICK TIPS

REFILLS: Super Sharp
Box with 25 double-sided blades.

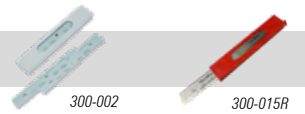

Price per unit

Razor Blade Scraper - Metal Body

300-003



- Steel body

Elegant metal scraper which takes razor blades. The blade can be exposed for work or safely withdrawn with one thumb movement. Ideal for small windows and windscreens.

The following razor blades can be used: 300-004.



QUICK TIPS

Recommended razor blades:



Price per unit

Razor Blade Scraper Small - Plastic Body

300-003SM



- Plastic body

Small compact holder made of durable plastic. Lies well in the hand and provides enough grip to apply force. The following razor blades can be used: 300-004.



QUICK TIPS

Recommended razor blades:



Price per unit

Razor Blade Holder for Razor Blades

300-005



- Long version: 30 cm

Special holder, 30 cm long, for razor blades. Now you are able to clean every unreachable window corner.



QUICK TIPS

Recommended razor blades:



Price per pack

OLFA® Multi - Purpose Scraper - 25 mm *OLFA*

300-SCR-S



- 25 mm Blade

Handy, high-quality disposable scraper Sharp edged scraper featuring 25 mm width stainless steel blade, and strong, durable handle to efficiently tackle most conventional jobs. Stainless steel blade offers better protection against rusting or longer use.

Disposal scraper, blade is not replaceable. Good for caulk removal, glass cleaning prior to window applications or post painting projects, light-duty floor scraping, wall and glass panel cleaning and more.



25 mm blade - straight price per piece

OLFA® Multi - Purpose Scraper - 43 mm *OLFA*

300-SCR-M



- 43 mm Blade

Same as above, but with 43 mm shaped blade.



43 mm blade - shaped price per piece

OLFA® Multi - Purpose Scraper - 60 mm *OLFA*

300-SCR-L

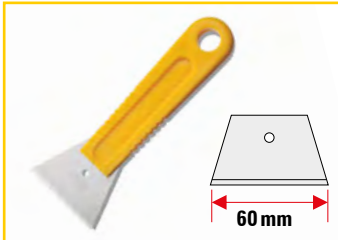

- 60 mm Blade

Same as above, but with 60 mm shaped blade.



60 mm blade - shaped price per piece



OLFA® 40 mm Compact Glass Scraper *OLFA*

300-GSR-2



- Robust and durable
- 6 Spare blades in the body

The OLFA 300-GSR-2 is a durable, multi-purpose mini scraper suitable for tight, narrow spaces and curved surfaces. The handle is made of light, strong and reinforced fiberglass, with an enveloping non-slip grip that provides the user with a comfortable grip and better control over the blade. All metal parts are made of stainless steel. Suitable for gently removing burnt-in stains, suitable for use on windows. Locked blade avoids movement in the handle during heavy applications.

The blade container easily snaps into the handle when the tool is in use and serves as a blade safety cap if needed. Made of high-quality Japanese carbon steel and designed for unmatched sharpness and superior edge retention.



works great for scraping:

- ADHESIVES,
- CERAMIC OR GLASS HOTPLATE
-
- DIRT
- EXCESS PAINT
- VARNISH
- SILICONE SEALANT
- SEALANT
- MORTAR
- GLASS SURFACES
- TILE SURFACES
- EXCESS ADHESIVE AND GROUT



Recommended razor blades:



120-GSB-2S



Price per unit

NT® Cutter Scraper *NT Cutter*

300-SC5P



- including 3 different blades: 28 mm, 36 mm and 60 mm

Handy, comfortable grip. Screw-locking-system holds blade firmly for extra safety. Including 3 different stainless steel blades for removing window, adhesive, paint, rust, etc.



Recommended razor blades:



300-BSC-21P

Price per unit

OLFA EXTRA HEAVY-DUTY SCRAPERS

OLFA® XSR Extra Heavy Duty Scraper **OLFA**

300-050



- 100mm(4") wide - In 3 different versions

Developed on request by industry professionals, hard working scraper with handle features extra-tough, die-cast metal handles, rounded with X-design non-slip rubber grip for comfort and stability and engineered with a built-in durable steel striking hammer tip for maximum striking power. Optimal size for centralized use on tough removal projects.

Includes 100 mm wide dual-scrape, carbon tool steel blade BS for maximum coverage and speed - use either sharp side or rough-edged side, depending on the job. Also fits flexible BSF blades (sold separately).

Easy, tool-free blade change. Handy »One-thumb« screw allows for extra blade tightening with a coin or screwdriver.

X-design 200 MM-long professional heavy-duty scraper comes equipped with the 100 MM-wide X 0.8 MM-thick blade.

No tools are required for blade replacement.

The 0.5 MM-thick BS, Flexible BSF and OLFA LB blade fit as well.

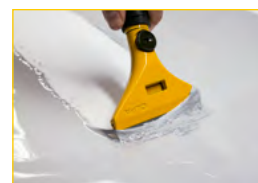

300-051



300-052

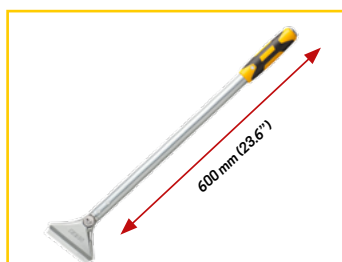

QUICK TIPS

Recommended razor blades:



300-050
300-051
300-052

200 mm length
300 mm length
600 mm length

Price per unit
Price per unit
Price per unit

OLFA® 120 mm Glass Scraper **OLFA**

300-GSR-1/3B



- 12 cm Wide

- Extra flat for better cleaning

OLFA's special scraper makes it easy to remove paint, glue residue, stickers, glass paint and all kinds of dirt from glass surfaces. The thin design of the 300-GSR-1 allows it to go very low and flat over the glass. Ideal for use on wet surfaces, as the blade, mounting plate and screw are stainless steel. The blade is 0.25mm thick and ground on both sides.

By loosening the fixing screw and moving the metal plate, the worn blade can be easily removed. The cover of the blade can be slid onto the handle, giving you even more grip while scraping.



QUICK TIPS

Recommended razor blades:

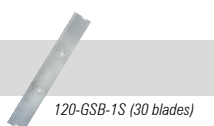

120-GSB-1S (30 blades)



COMES WITH 3 SPARE BLADES (120-GSB-1S).

Price per unit

Portable Dispenser for Plastic Cover

350-150



- compact and portable
- perfect to cover door panels of cars, dashboards etc.

This small plastic dispenser is designed for a roll of plastic cover 350-151. Ideal for masking car panels before installing window . The dispenser has a serrated tear-off edge, so the masking can be easily torn off to size.



Dispenser size: 88 x 110 mm



Price per unit

Plastic Cover with Adhesive Tape - on Roll

350-151



- Fits in 350-150 dispenser
- Roll size (unfolded) 55 cm x 33 m

Cover on a roll, which can be placed in the portable dispenser. This masking has adhesive tape on one side, so that the can be positioned and stay on a panel immediately upon unrolling. The cover foil is 55 cm high; ideal for dashboards, parcel shelves, door panels, etc. Roll length 33 m



For best result, use:



350-150

Price per unit

Soak It Up - Tint Rope 3m

NEW

300-031



- Absorbs 4 times its own weight in water
- Does not lint

Indispensable when tinting car windows. To prevent water from running into seams and cracks, this moisture-absorbing braided rope is the way to go. Place the rope between the window and the rear shelf, between the door panels or between the dashboard and the windscreen. Water running down from the glass will be sucked up by the rope.

After the job is done, wring it out, let it dry and it's ready for another use.

The cover foil is 55 cm high; ideal for dashboards, parcel shelves, door panels, etc. Roll length 33 m

Soft without damaging the glass.
Strong water absorption.
Convenient storage.



Price per unit

Foldable Water Bucket

NEW

400-014



- 11 L capacity
- 4 cm thick x 35 cm diameter

This is a Must-Have! It doesn't get any prettier than this!

Every installer and fitter who works with moisture and water knows this the problem: where do you leave your damp cloths, wet squeegees, or wet waste after assembly?

Or do you need a water bucket on site that takes up little space?

Just take the foldable water bucket with you in your toolbox and fold it open when needed. It's that easy.

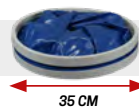

- SIMPLY PLACE IT IN YOUR TOOLBOX
- STRONG WATERPROOF SIDES
- WITH HANDLE
- PLACE YOUR WET USED TOOLS IN THE BUCKET
- DEPOSIT ALL WET WASTE IN THE BUCKET
- EASY TO HANDLE AND CARRY

Price per unit

SCRAPERITE®

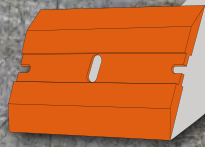

Airframe
Powerplant
Composites



Gelcoat
Plated metals
Adhesives



Body panels
Glass
Wheels



MRO
Production
Safety



Stovetops
Countertops
Tile



Furniture
Monitors
Break room

Soft Surface Scraper Mini *SCRAPERITE*

300-006



- New type of holder for better grip
- 6 Scrapers included

Removing adhesive residue and hard bits of dirt from surfaces can be a problem. Scouring pads, blades and metal scrapers can cause scratches. That is why Scrapperite's orange scrapers are a godsend. This small plastic holder has an orange polycarbonate razorblade and does not scratch.

You can use it on car paint, acrylic, hard foam, wood, glass, etc. A handy and indispensable scraper for every mechanic and should actually be available in every Tool Bag, Tool Box and Tool Station. In this way you can be sure that the cleaning, removal and scrubbing is done properly and without problems. Separate scrapers are also available.

The scraper has a sharp edge on both sides so that, for example, glue residue can be scraped up very easily. TIP: scrape it to one heap and scoop it onto your cleaning cloth. Repeat this procedure until all glue residues are gone.



QUICK TIPS Comes with 6 spare blades:



For best results use:



600-Z0415



600-Z0440

Price per set

Soft Surface Scraper Mini Combo *SCRAPERITE*

300-006-CMB



- New type of holder for better grip
- 6 Scrapers included

Removing adhesive residue and hard bits of dirt from surfaces can be a problem. Scouring pads, blades and metal scrapers can cause scratches. That is why Scrapperite's orange scrapers are a godsend. This small plastic holder has an orange polycarbonate razorblade and does not scratch.

You can use it on car paint, acrylic, hard foam, wood, glass, etc. A handy and indispensable scraper for every mechanic and should actually be available in every Tool Bag, Tool Box and Tool Station. In this way you can be sure that the cleaning, removal and scrubbing is done properly and without problems. Separate scrapers are also available.

The scraper has a sharp edge on both sides so that, for example, glue residue can be scraped up very easily. TIP: scrape it to one heap and scoop it onto your cleaning cloth. Repeat this procedure until all glue residues are gone.



QUICK TIPS Comes with 3x3 spare blades:



For best results use:



600-Z0415



600-Z0440

Price per set

Big Gripper *SCRAPERITE*

300-011CMB



- Extra pressure and strength while scraping

A solid addition to the Lil' Gripper range. The Big Gripper is perfect for heavy-duty jobs. It fits firmly in your hand, resulting in an improved strength on the surface. Now you know that even heavy-duty cleaning will go smoothly!



QUICK TIPS Comes with 3x3 spare blades:



Price per unit

The Wide Gripper - 10 cm - 4" *SCRAPERITE*



- Extra wide
- Strong plastic grip - will not break
- Comfortable to hold
- With 1 or 5 blades



The big brother of the Scrapperite family. This 4" (10 cm) wide scraper helps you tackle the toughest jobs by quickly removing adhesive residue, dirt, etc. from flat surfaces. The large polycarbonate scraper can be used on both sides and does not scratch surfaces. It's also easy to put in place and remove without fear of hurting yourself.

The Giant Gripper is entirely made of plastic, so it will never rust or oxidize. An indispensable tool for any signmaker, window tinter, painter or cleaner.

Scrapperite Blades - Orange

300-012



Price per unit

Scrapperite Blades - Black

300-013



x5



QUICK TIPS Comes with 5 spare blades:



Price per pack



RENEWED, THOUGHT OUT AND UNMATCHED

**ADHESIVE and DIRT removal
without causing any damage**



Scraperite is an American company that specializes in the removal of hand dirt, glue residue, hard obstacles, etc. from fragile and delicate surfaces. The blades are made of a special plastic mix and come in different sizes and shapes, so that an optimal result can be achieved without damaging the surface.

PERFECT FOR WINDOW INSTALLERS, CAR WRAPPERS, INTERIOR INSTALLERS, ADVERTISING AGENCIES, ETC.

Scraperite ORANGE:



The Scraperite ORANGE is manufactured the softest material we offer and is a perfect tool for use on delicate surfaces. The orange version is made from Celcon and is approved by Boeing for use on Alclad aluminum airframes. Works great on painted and delicate surfaces.

Scraperite BLACK:



The scraperite BLACK is harder and intended for heavy-duty cleaning. This new, harder material is more resistant to breakage and wear. Designed for use in industrial applications where repeated use is normal. It also does a better job with more stubborn adhesives, sealants, oxidation, corrosion, etc. on less sensitive surfaces.

Scraperite Blades - Orange

300-009

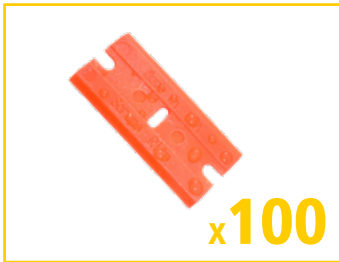

The Scraperite ORANGE is made of the softest material we offer and is a perfect tool for use on delicate surfaces. The orange version is made of Celcon and is approved by Boeing for use on Alclad aluminum airframes. Works great on painted and delicate surfaces

For use on the following substrates:
Acrylic, Brass, Ceramic tiles, signs, Glass, Formica, Hardwood, Laminate, Mirrors, Painted surfaces, Polycarbonate, Vinyl flooring, Windows, automotive paints, etc.

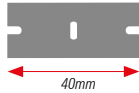

QUICK TIPS

Fore use in scraper holders:



300-006

300-011CMB

Price per box

Scraperite Blades - Black

300-009BL

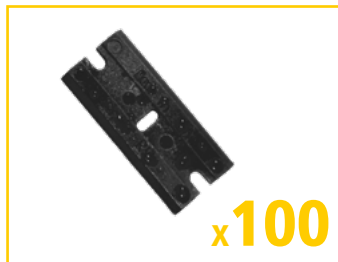

The scraperite BLACK is harder and intended for heavy-duty cleaning. This new, harder material is more resistant to breakage and wear. Designed for use in industrial applications where repeated use is normal. It also does a better job with more stubborn adhesives, sealants, oxidation, corrosion, etc. on less sensitive surfaces.

For use on the following substrates:
Aluminum, Brass, Ceramic Tiles, Chrome, Glass, Fiberglass, Granite, Marble, Mirror, Stainless Steel etc.

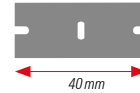

QUICK TIPS

Fore use in scraper holders:



300-006

300-011CMB

Price per box

Scraperite Blades - Orange

300-009C



The familiar Scraperite ORANGE but with special curved cutting edges. The curved scrapers are rounded on two sides for easier scraping. The scrapers are also slightly bendable so you can choose whether to press the scraper flat on the substrate or just the scraper edge. Also ideal for concave surfaces.

For use on the following substrates:
Acrylic, Brass, Ceramic tiles, signs, Glass, Formica, Hardwood, Laminate, Mirrors, Painted surfaces, Polycarbonate, Vinyl flooring, Windows, automotive paints, etc.

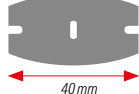

QUICK TIPS

Fore use in scraper holders:



300-006-CMB

300-011CMB

Price per box

Scraperite Blades - Black

300-014



- 10 cm wide
The Scraperite WIDE blade is made of the softest material we offer and is a perfect tool for use on delicate surfaces. This double edge orange version is made of Celcon and is approved by Boeing for use on Alclad aluminum airframes. Works great on painted and delicate surfaces.

For use on the following substrates:
Aluminum, Brass, Ceramic Tiles, Chrome, Glass, Fiberglass, Granite, Marble, Mirror, Stainless Steel etc.

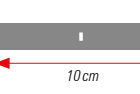

QUICK TIPS

Fore use in scraper holders:



300-013

Price per box



Fast Vinyl Removal

2 versions available:



Smooth Serrated

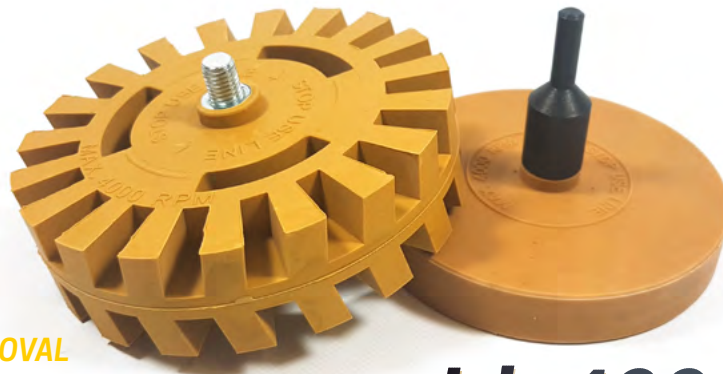

KEEP IT SIMPLE AND EASY! 2 SPECIAL ERASER DISKS FOR FAST AND EASY REMOVAL SOLUTIONS. NO STRESS, NO SMELLY ENVIRONMENT, NO WASTE OF TIME.

with 4000 rpm!

Strip - It™ Eraser Disk

300-010



Smooth

Fast removal of vinyl and stickers

Removing vinyl of a car can be a difficult and time consuming job. Especially when the vinyl is old and tears easily.

Or what to think of removing reflective vinyl.

Use the Strip-IT Disk to remove stickers, adhesive s, decals, labels, stripings, etc. from cars, boats, trucks, motorcycles, glass window panes, etc. Also ideal for removing adhesive residue.

Safe

The STRIP-IT Disk is safe and does not scratch or damage quality car paints and acrylic and urethane paints, glass, metal, etc. Do not use on soft, delicate or fresh paints or coatings.



- SPECIAL FORMULATED RUBBER
- SIZE: 90 X 15 MM
- RECOMMENDED SPEED: 3000 - 4000 RPM
- DRILL ADAPTER INCLUDED

Price per box

Strip - It™ Eraser Disk T - Series

300-010T



Serrated

Serrated for improved efficiency

For removing vinyl , striping, stickers, decals, adhesive residue, double-sided tape or any other adhesive .

The special serrated edges keep the disk cool during use and enable easy handling.

Use the Strip-IT T-series to remove stickers, adhesive s, decals, labels, stripings, etc. from cars, boats, trucks, motorcycles, glass window panes, etc. Also ideal for removing adhesive residue.

Safe

The STRIP-IT T-Series is safe and does not scratch or damage quality car paints and acrylic and urethane paints, glass, metal, etc. Do not use on soft, delicate or fresh paints or coatings.



- SPECIAL FORMULATED RUBBER
- SIZE: 102 X 25,4 MM
- RECOMMENDED SPEED: 3000 - 4000 RPM
- DRILL ADAPTER INCLUDED

Price per box



QUICK TIPS

Instructions for use:

Use the adapter for mounting it on a drill. Set drill to the right speed (rpm). Exert light pressure and move the disk back and forth whilst erasing. Any remaining adhesive residue or deposits can be polished away with SOTT 600-Z0415 Right-Off Adhesive Remover or 600-T800 Industrial Degreaser. Test on a small area before you start erasing large areas.

CUTTING TOOLS

Simplify the cutting of your adhesive with our range of cutting aids. Cut your media accurately and with no offsets, for a result that is synonymous with perfection.



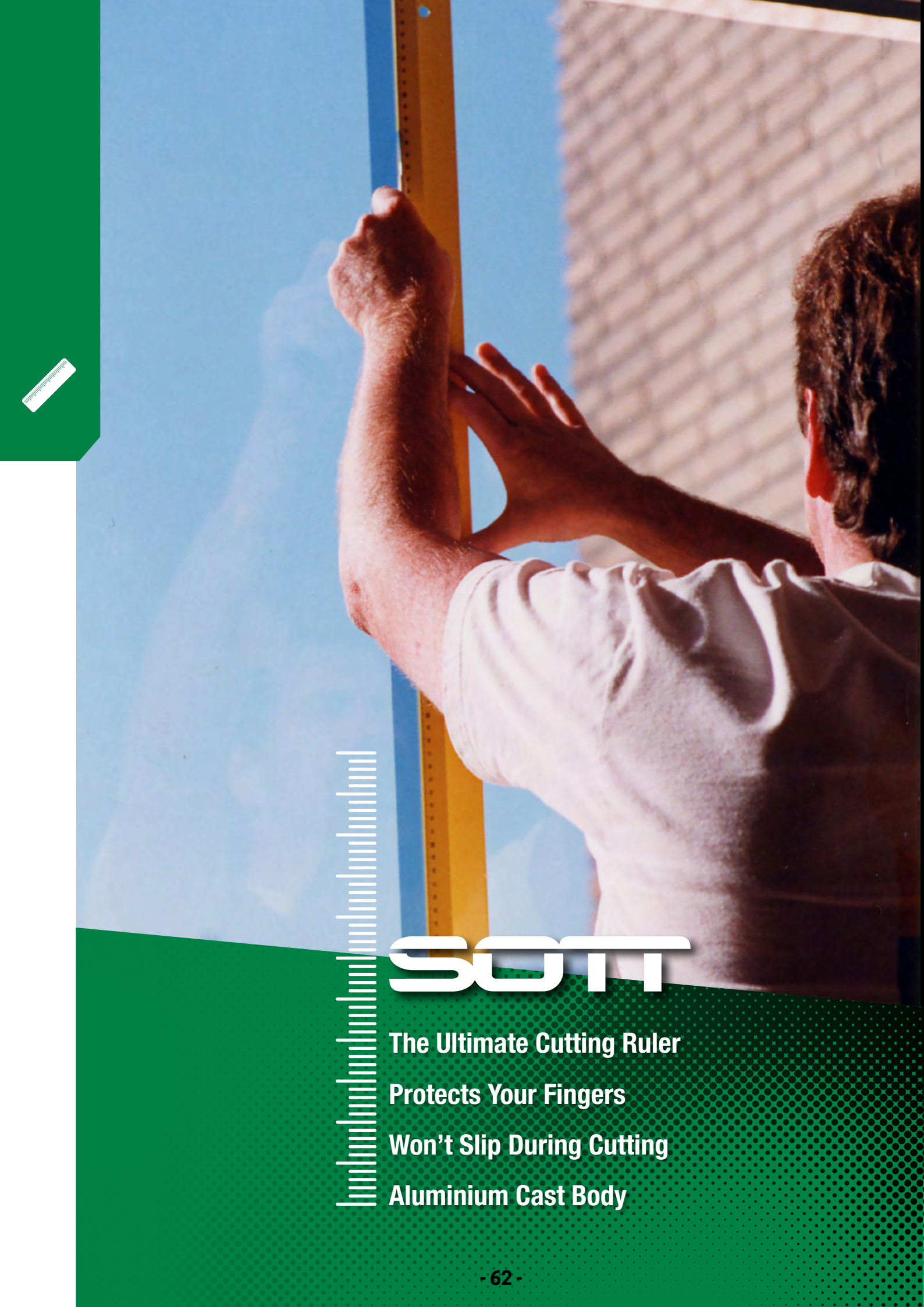

SOTT

The Ultimate Cutting Ruler

Protects Your Fingers

Won't Slip During Cutting

Aluminium Cast Body



Anti-slip cutting ruler, indispensable for signmakers, window tint installers and interior installers, that need to cut straight lines without the cutting ruler sliding all over the place.

A unique solid aluminium cutting ruler with all of the advantages that you could possibly wish for: strong, stable, straight, but above all safe. This allows you to make long cuts with ease, without the fear of the knife 'jumping' and running across your fingers. The workshop becomes safer and production is increased. Large sheets of and thick, rigid materials can now be cut with ease.

The cutting ruler that CAN'T SLIP during cutting

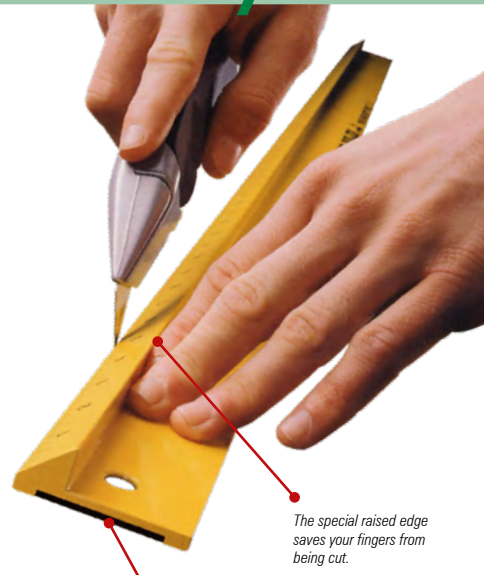

The special raised edge saves your fingers from being cut.

The thick anti-slip layer not only prevents slipping, but also protects your work from damage.

Aluminium cutting ruler with raised edge to protect fingers

The calibrations are clearly displayed in centimetres. This allows cuts to be made straight to size. The special antislipunderside ensures perfect stability on every surface, be it glass,acrylate, card, linoleum, rubber or anything else for that matter; the ruler remains perfectly still during cutting. The ideal tool for large colour prints and the like. The anti-slip foam layer prevents the ruler from coming in to contact with your work preventing it from damage when the ruler is slid around. Very handy!

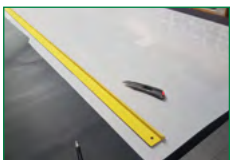
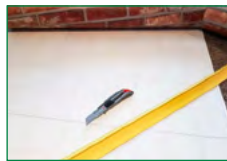

- CUTS SELF ADHESIVE S
- CUTS POLYESTER WINDOW S
- CUTS PLASTIC PANELS AND FOAM BOARDS
- MAKE SUPER STRAIGHT LINES



Available in 4 different lengths:

250-CB50	50 cm	Price per unit
250-CB100	100 cm	Price per unit
250-CB155	155 cm	Price per unit
250-CB200	200 cm	Price per unit



- Solid aluminium

Special 9 cm handle with double-sided adhesive, to be mounted on the ruler



Price per unit

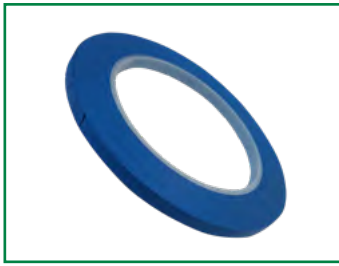

- Define cutting lines before install PPF
- Create a flexible ruler for cutting purposes

This 6mm (.25") plastic tape is a revelation for every installer. Easy to stretch and shape, does not leave adhesive residue.

Quite thick, so doesn't tear or break easily. Cutting and Contour Tape is ideal for:



Establish cutting lines:

If needs to be cut to follow a desired form then Cutting and Contour Tape is the ideal solution. First apply the , use the tape to create the desired form, and then simply cut carefully along the tape. The red and blue panel shown on the photo can be cut entirely freehand. The top of the full colour print that runs away slightly at the top can also be cut perfectly using the Cutting and Contour Tape.:



PPF bulk installation with cutting tape

Use this tape to place the correct cutting lines. Then install the PPF as you normally would. Now cut through the ppf , and on top of the cutting tape. Pull the cutting tape from under the ppf while spraying water under the . Result: nice cut and the paint is not touched.



QUICK TIPS

Size: 6 mm x 55 m

Price per roll



- Define cutting lines before install PPF
- Create a flexible ruler for cutting purposes

This 12 mm plastic tape is a revelation for every installer. Easy to stretch and shape, does not leave adhesive residue.

Quite thick, so doesn't tear or break easily. Cutting and Contour Tape is ideal for:



QUICK TIPS

Size: 12 mm x 55 m

Price per roll

3M Knifeless Tape™

NO KNIFE. NO DAMAGE. NO WORRIES.

Removable Cutting tape that Easily CUT

Special removable tape with embedded cutting wire. Perfect tool to make clean cuts through digital prints, laminated s, car wraps, carbon- and other structured s when bonded to cars or other surfaces. Not suitable for stone chip resistant PU s.

3M® Knifeless Tape Finish Line 3M

350-206



Rotates easily in any direction with contours, curves and edges of the car. Accurately and efficiently cuts through selfadhesive without the use of a knife and without surface damage, resulting in perfectly straight, smooth lines or curves.

- **CUTS MOST VINYL WRAP S.**
- **FOR APPLICATIONS WITH ONE OR MORE VINYL LAYERS**

Price per roll

3M® Knifeless Tape Bridge Line 3M

350-207



This type of tape is wider and can therefore adhere to both sides of the body parts. This avoids the risk of cutting into the underlying rubbers, for example, or of the cut not being exactly in the middle.

- **FOR CUTTING AT DOORS AND SEAMS**
- **FOR CUTTING LAMINATED PERFORATED WINDOW S**
- **FOR APPLICATIONS WITH ONE OR MORE VINYL LAYERS**

Price per roll

3M® Knifeless Tape Design Line 3M

350-208



Allows stretching, follows contours and turns easily in any direction. Excellent for creating designs & stripes with no extra steps required to achieve a perfect cut.

- **STRETCHES SLIGHTLY AND TURNS EASILY IN ANY DIRECTION**
- **BEST OPTION FOR VERY TIGHT CURVES.**
- **TAPE CAN BE TORN BY HAND FOR FASTER APPLICATION.**
- **FOR SINGLE LAYER VINYL APPLICATIONS.**

Price per roll

3M® Knifeless Tape Perf Line 3M

350-209



Easily cut an even margin between window graphics and window rubber.

- **USED FOR CUTTING LAMINATED PERFORATED WINDOW S (ONE-WAY VISION) AND CREATING A UNIFORM RELIEF CUT ALONG RUBBER MOLDS BEFORE APPLYING EDGE SEALING TAPE.**

Price per roll

3M® Knifeless Tape Precision Line 3M

350-213



Accurately and efficiently cut through self-adhesive without using a knife or damaging the surface, resulting in perfectly straight, smooth lines or curves.

- **CREATE A TIGHT, INVISIBLE SEAM BETWEEN TWO DIFFICULT TO WORK WITH S.**

Price per roll

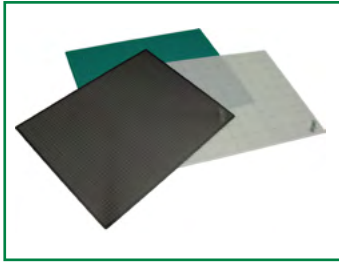

- 3 mm (120 mil) thick double layer calibrated cutting mat
- Available in black, green and transparent

High quality cutting mat which closes after every cut, preventing your knife from following previous cuts. These mats are triple layer enabling both sides to be used.

So they'll last twice as long!

Makes that perfect cutting table

The mat has a solid core which ensures that it remains flat on the table without curling.

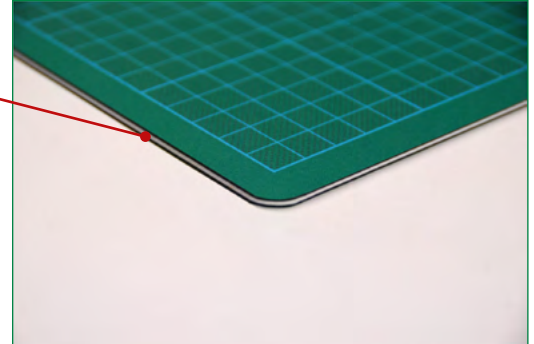

The calibrations on the upper side allow the accurate positioning of the or cutting ruler.

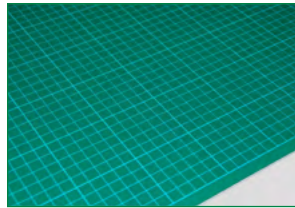
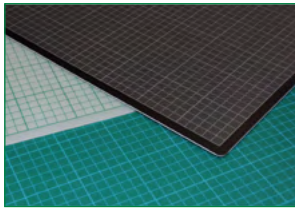

Handy tip: Use a number of smaller mats on a large table - e.g. 2 x 3 (60x90) instead of one large mat. Experience has taught us that some areas of a table are used more often than others, so the mats wear out quicker in some places than others.

If you follow this advice you should only have to replace a single small mat instead of the whole table area. Simply attach the mat to the table with double sided tape. Never place warm or hot things (e.g. cups of coffee) on the cutting mat. This will cause permanent surface damage to the mat.



Cutting tracks are eliminated ensuring every cut is perfect. Even cutting in the finest detail is possible.

Green

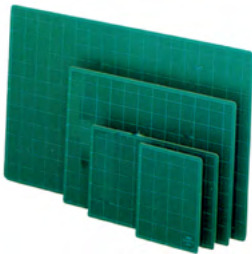

- 250-010** 30 x 45 cm
- 250-014** 45 x 60 cm
- 250-016** 60 x 90 cm

Black

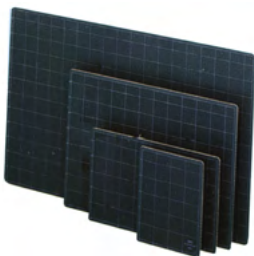

- 250-011** 30 x 45 cm
- 250-013** 45 x 60 cm
- 250-017** 60 x 90 cm

Transparent



- 250-012** 30 x 45 cm
- 250-015** 45 x 60 cm
- 250-018** 60 x 90 cm

Available in a variety of colours and sizes

Price per unit



- One side shows cm, other side shows inches

CM series multi-purpose self-healing cutting mats are 2 mm thick and specially designed for use with OLFA standard duty cutters, heavy-duty cutters, art knives, rotary cutters and specialty cutters. Double-sided with green base color and white grid lines with a metric grid on one side and an inch grid on the other. Grid lines are designed for easy measuring and for accurate cutting of straight lines and precise angles. Self-healing, an OLFA original technology refers to the ability of the surface to return to its original shape after being cut and are ideal for general quilt cutting. A three-layer structure and soft cutting surface realize smooth cutting even after many years of use. OLFA CM mats protect your work area and greatly extend the life of your blades.

QUICK TIPS

WARNING!

- Keep the mats away from sunlight and heat
- Mats must be stored flat
- Not suitable for use with steam irons
- Not suitable for use with OLFA MC-45 and MC-45/DX

250-CM-A4	20 cm x 30 cm	Price per unit
250-CM-A3	20 cm x 45 cm	Price per unit
250-CM-A2	45 cm x 60 cm	Price per unit
250-CM-A1	60 cm x 90 cm	Price per unit

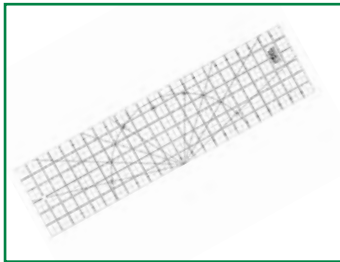

- 15 x 60 cm
- Gridded with various angles

The OLFA ruler has a non-slip surface for stable and safe cutting. The matte acrylic surface with black numbers provides clarity on light and dark surfaces. The ruler allows the user to make precise measurements and cutting angles while working. Features a compass with pivot point for 15°, 30°, 45°, 60° and 90° angles.

Full grid model with centimetre indication. Suitable for both right- and left-handed users. many years use. OLFA CM mats protect your work area and greatly extend the life of your blades.

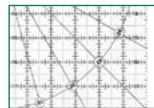

QUICK TIPS

15 cm x 60 cm

Price per unit



- 90° angle
- Anodized aluminium

This stable aluminium ruler allows you to mark off and cut corners and holes with precision. A handy tool for cutting window s and interior s to size in advance on your cutting table.

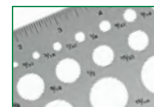

QUICK TIPS

31 x 31 cm

Note:
all sizes are shown in inches

Price per unit

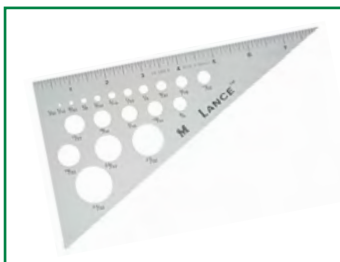

- 90° angle
- Anodized aluminium

This stable aluminium ruler allows you to mark off and cut corners and holes with precision. A handy tool for cutting window s and interior s to size in advance on your cutting table.



QUICK TIPS

21 x 12 cm

Note:
all sizes are shown in inches

Price per unit

The Edge - Finisher ^{NEW}



- Clever mini rulers for perfect edge finishing

Skillfully marking, cutting and finishing edges and corners is not always an easy task. Especially when all edges and corners have to be uniform. With these clever guides, this is a piece of cake. Place the mini ruler in the desired corner or edge and make exactly parallel cuts or markings.

Perfect for measuring and cutting



Marking off with precision

This is handy: there is a 5 mm gauge on the flat strip and a hole every 5 mm. Place your pencil or marker there and then, draw a perfectly parallel mark.

Cutting perfectly parallel and straight

Next to the holes are slots to insert your knife. Now easily cut each straight and parallel in a single movement.

90°

250-CG90

120°

250-CG120

140°

250-CG140



The Edge-Finisher 90
With 90° angle

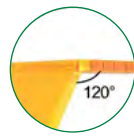

The Edge-Finisher 120
With 120° angle

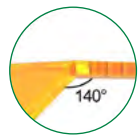

The Edge-Finisher 140
With 140° angle



QUICK TIPS

The Edge-Finishers are available in 3 different angles: 90°, 120° and 140° respectively.



Price per unit

Mini Squeegee with Cutting Slots ^{NEW}

250-CG



- Ideal for small areas - Cut edges with precision

Handy little foldable squeegee for pressing into small seams and gaps. The trapezoidal shape provides additional possibilities in the corners.

Even more interesting are the special cutting slots, which are all 2 mm apart. Insert your knife into the desired slot and now use the squeegee as a guide to make a nice straight cut in the .

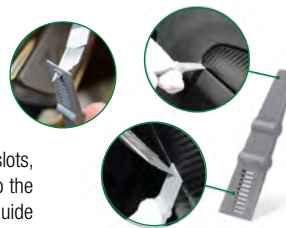

Press into the difficult corners.
Insert your knife into the slot and cut.

Price per unit

SQUEEGEES

Get a perfect finish to for your adhesive with our range of professional quality squeegees. Our squeegees provide a smooth, even finish by removing air bubbles and excess water.



CS Squeegee 13 cm

NEW

150-CS13

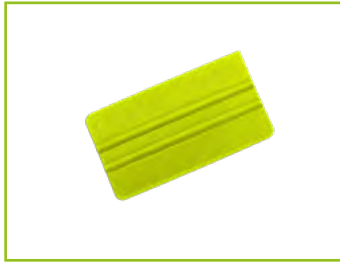

By taking the best features of existing squeegee, we created the perfect one for interior decoration in PVC free!
13 cm, hardness: rigid, one 90° angle



QUICK TIPS

Compatible felt pad:



150-CFS-13

Price per unit

Squeegee Grinder

350-210



- Is your squeegee burred?
- Is your squeegee no longer straight and smooth due to wear and tear?

A squeegee often is a personal favorite and an applier will always carry it with him. But what can you do when this particular squeegee has worn out so much, it's round and full of burrs? Keep it! Our Squeegee Sharpener is the solution to your problem! This smart tool has a small knife in its groove, fully smoothening the squeegee when pulled through. Smart and simple!



QUICK TIPS

Perfect for Smart PDLC (liquid Crystals) if you need to reduce the size by a few mm, without any damage unlike regular blade cut.

Price per unit

Rivet Brush

150-037



- 25 mm

25 mm brush for applying vinyl on surfaces with rivets. Also, very useable for applications with an embossed or structured surface.

Price per unit

Felt Squeegee

150-041



- Standard quality

Perfect to use for CarWrapping and applications of vinyls and s without applicationtape. Won't scratch the vinyl.

Besides its use on vinyl, this squeegee is also more and more used to shrink window tinting as it will always slide even if the surface is warm, unlike plastic card squeegee

Price per unit

3M® Gold Squeegee 3M

150-3MPA-1



The best known and most widely used squeegee. Stable and almost non-wearing.
10 cm width

QUICK TIPS is your squeegee no longer straight and smooth due to wear and tear?



350-210

Price per unit

3M® Blue Squeegee 3M

150-3MPA-2



Blue, flexible squeegee. We recommend this squeegee for carwrapping. It will follow every curved and round surface with ease. Use our special wrap felt to make this squeegee complete.
10 cm width

QUICK TIPS is your squeegee no longer straight and smooth due to wear and tear?



350-210

Price per unit

OMEGA 10 Squeegee SOTT 150-LM10

OMEGA 13 Squeegee SOTT 150-LM13



- 10 cm
The OMEGA 10 squeegee by SOTT unites all the features that an installer can expect of a squeegee.



- Extra wide: 13 cm
Same product as OMEGA 10 but extra wide: 13 cm.



Flexible and malleable

The OMEGA Squeegee follows all surface contours and curves impeccably.

Stiff and sturdy

The OMEGA Squeegee by SOTT is made of a rubber/plastic composite that makes it stable and exerts good counter pressure when you are power squeegeeing.

QUICK TIPS is your squeegee no longer straight and smooth due to wear and tear?



350-210

Price per unit

SQ Squeegee - Straight Corners

150-SQ10



- Straight corners
Hard plastic squeegee with four straight corners instead of all common squeegees that have rounded corners. This can be helpful where one wants to be able to push into corners. The edge is also thinner than conventional squeegees.
10 cm width



Price per unit

Teflon Gold - Flexi Medium Firm

150-015



- Flexi Medium Firm
- Heat resistant

Many window installers say that the Gold card provides more friction on for better gripping during the heat forming process. It is on the high end of "medium" on our flexibility scale, which makes it fantastic for water extraction during squeegeeing or bumping dry.

Price per unit

Teflon Blue - Soft

150-015BL

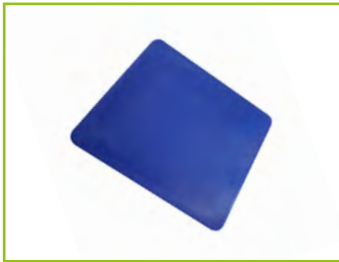

- One side flat
- One side curved

The curved edge is designed to encourage a finger or bubble to disperse outward which reduces the chances of a crease.

Price per unit

Teflon Platinum - Flexi - Firm

150-015PT



- One side flat
- One side curved

The curved edge is designed to encourage a finger or bubble to disperse outward which reduces the chances of a crease.

Price per unit

Teflon White - Hard

150-015WT



- One side flat
- One side curved

The curved edge is designed to encourage a finger or bubble to disperse outward which reduces the chances of a crease.

Price per unit

Teflon Black - Flexi Soft

150-016



- Flexi and soft
- Heat resistant

The BLACK "TEFLON" HARD CARD is second to the White hard card in popularity. This card provides a little more flexibility than the WHITE or the GOLD, but it is stiffer than the BLUE which makes it great for both flat and curved glass surfaces.

Price per unit

Wrapedge - Alcantara Buffers

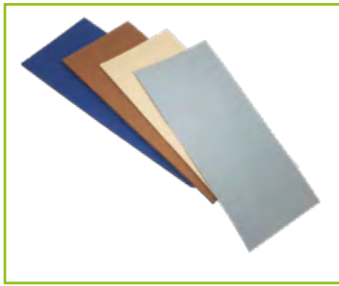

- For scratch free installations

Read all information on the next page.



x12 **500-038** 1 mm sponge thickness



x12 **500-040** 3 mm sponge thickness



x12 **500-039** 2 mm sponge thickness



x1 **500-037** 0 mm sponge thickness 2 cm x 2 m

Price per pack

Wrapedge Trial Pack - 4 Different Samples

500-041



A clean wrapping result is partly dependent on easy squeegeeing without scratching! The WrapEdge is made of Alcantara and has a special moisture-absorbent sponge layer for wet work, for an even better result.

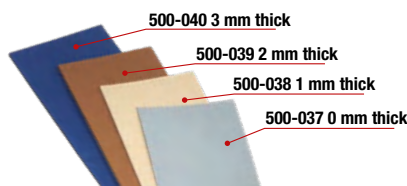

The Trial Pack contains one of each WrapEdge

Price per set



QUICK TIPS

Protective Felt - Wool - 2 mm SOTT

500-018



- Self adhesive; will not come loose when wet
- Available in two widths

Special high quality industrial grade wool felt. Does not become "hairy" during use and is resistant to moisture and cleaning products so this felt will not come loose. The combination of wool felt with its thickness of 2 mm allows an even pressure to be applied during application while the risk of scratching is eliminated.



QUICK TIPS

Available in two widths.
10 cm wide or 13 cm wide

500-018
500-019

10 cm
13 cm

Price per unit
Price per unit

Protective Felt - Velours - 1 mm SOTT

500-045

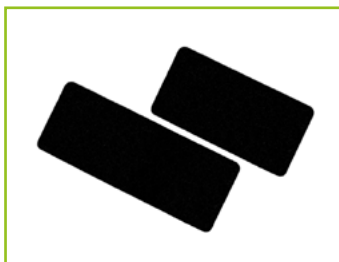

- Self adhesive; stays in place
- Specially intended for car wrap s and soft cast applications

Special "felt" with an industrial grade adhesive layer that will not come loose. This 1 mm (0.04) thin protective felt is intended for use during car wrapping and allows extra pressure to be applied during application while the risk of scratching is eliminated. We recommend this version for use on glossy s.



QUICK TIPS

Available in two widths.
10 cm wide or 13 cm wide

500-045
500-046

10 cm
13 cm

Price per unit
Price per unit

Teflon Squeegee Tape - Super Smooth 5 m ^{NEW}

500-047



- 25 mm x 5 m
- PTFE coated fibreglass

Do you want your squeegee or backing slitter to glide beautifully and smoothly over? Then, the Teflon Squeegee Tape is just what you need.



Simply stick it on any surface and you're done. Also ideal for reducing friction on rods, guides and strips. Heat resistant. Does not absorb moisture. Roll length: 5 m



QUICK TIPS

Just cut off what you need and stick it on your squeegee, backing slitter or whatever.

Price per unit

KEEPIN' IT SCRATCH-FREE AND SHINY

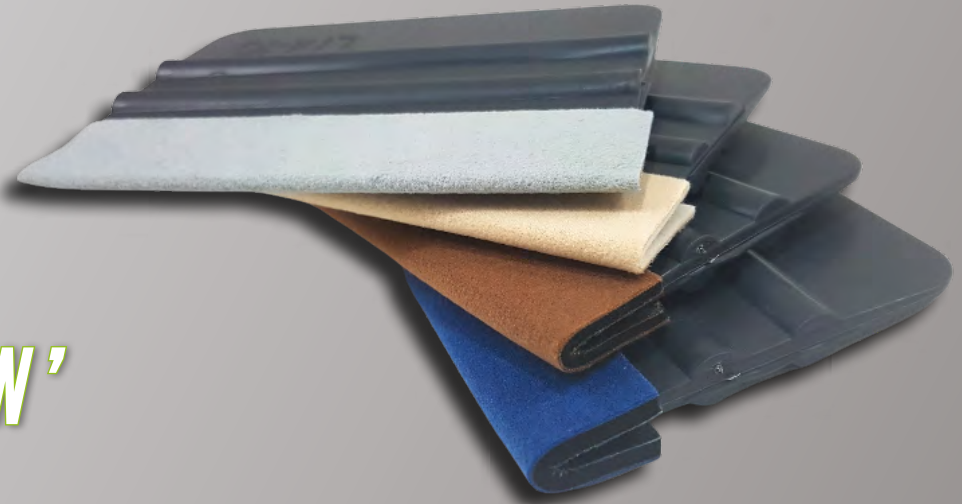

Wrapping pros all over the world use them: felt tips or sleeves that help your squeegee slide smoothly, called »buffers». But what is a good solution when installing high gloss s? And what about chrome and mirror s? Scratches do happen. SOTT has the solution: the WrapEdge, made of soft, structureless alcantara. Available in 4 types. These »buffers» do exactly what every installer and wrapper wants, because each type of WrapEdge has a preferred application.

HIGH GLOSS PVC



Many installers have experienced that squeegeeing high gloss s (especially dark colours) causes scratches.

WrapEdge helps to avoid that! Because the middle layer absorbs and retains moisture, you can wet it with some soapy water and presto! the world's best squeegee is a fact.

Your squeegee suddenly slides perfectly over the vinyl while the pressure is evenly distributed and the is superbly applied with no issues whatsoever.

MIRROR S?



Chrome, polyester or mirrored - they all have one thing in common: they easily scratch when you install them.

Wouldn't it be nice if you could simply squeegee them down and not have to worry about scratching?

VARIOUS THICKNESSES



The WrapEdge buffers have a sponge middle layer that serves 3 functions:

- 1: It holds moisture so it can contain the soapy water for wet squeegeeing.
- 2: Wet installing of window becomes a breeze, because the sponge layer absorbs the squeezed-out moisture at the edge.
- 3: The thickness of this layer ensures an even pressure distribution when squeegeeing and flawlessly follows the channels and other recesses of the vehicle body parts when the is pushed in.

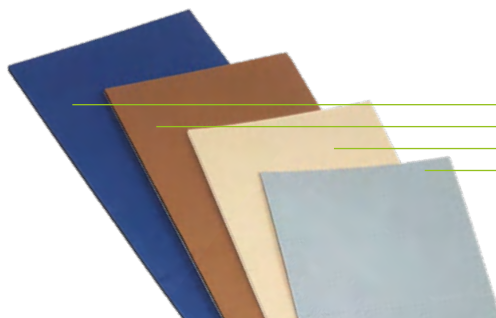

WrapEdge

The WrapEdge buffers are available in 4 different types, each one for a specific application. Check the back for more information.

The 4 different WrapEdge buffers are all made of high-quality, structure-free alcantara. The difference mainly lies in the moisture-absorbing middle layers, which perfectly serve as a moisture reservoir to prevent scratching when wet squeegeeing. The thicknesses differ from type to type. The special adhesive on the back is moisture-resistant



Thin and strong alcantara. Spreads the squeegeeing pressure evenly. Can be moistened for an even better result. Contains no sponge layer.



The buffers are slightly larger than a standard squeegee, so the squeegee edges don't scratch.



Available on a roll 2 cm x 2 mtr.

WrapEdge 00



Sturdy alcantara with a 1 mm sponge layer. Spreads the squeegeeing pressure ideally. Extremely suitable for chrome, high gloss, and polyester s.



The added 1 mm sponge layer makes the squeegee's edge rounder and distributes the pressure over its full width. If necessary, wet the buffer to prevent scratches.



Available in sets of 12, pre-cut in 2 sheets.

WrapEdge 01



Sturdy alcantara with a 2 mm sponge layer. Spreads the squeegeeing pressure ideally. Extremely suitable for chrome, high gloss, and polyester s.



The added 2 mm sponge layer makes the squeegee edge thicker and rounder and distributes the pressure over its full width. If necessary, wet the buffer to prevent scratches.



Available in sets of 12, pre-cut in 2 sheets.

WrapEdge 03



Sturdy alcantara with a 3 mm sponge layer. Perfect for wrapping in recesses and over swages as it can easily form the in and over those areas.



The rounded edge of the squeegee is made thicker and is therefore very suitable for channels in company cars and vans. If necessary, wet the buffer to prevent scratches.

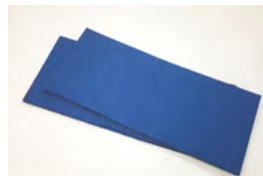

Available in sets of 12, pre-cut in 2 sheets.

WrapEdge 04

WrapEdge-00	0 mm sponge thickness	500-037
WrapEdge-01	1 mm sponge thickness	500-038
WrapEdge-02	2 mm sponge thickness	500-039
WrapEdge-03	3 mm sponge thickness	500-040

WrapEdge
by **SOTT**

PPF squeegees for the professional PPF installer

PAINT PROTECTION (PPF) IS HOT THESE DAYS. BUT HOW DO YOU PROPERLY INSTALL THIS VERY SPECIAL AND EXPENSIVE ? GOOD TOOLS ARE HALF THE BATTLE. WITH THE FOLLOWING SQUEEGEES YOU HAVE EVERYTHING YOU NEED FOR A PERFECT INSTALLATION AND SATISFIED CUSTOMER.

SOTT® The Blue One Squeegee - Soft **SOTT**

150-PP1

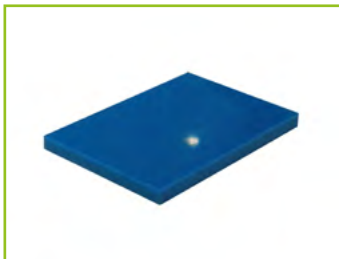

- Soft and flexible

Small, very flexible rubber squeegee for the wet application of PU paintwork protection s on cars. This small squeegee follows every curvature of the car bodywork eliminating all application liquid simply and effectively.



Price per unit

3M® Wet or Dry Rubber Squeegee - ULa Soft **3M**

150-PP2



- 7 cm x 10,5 cm

The squeegee is made of very soft rubber and follows literally any shape or contour of the surface. This squeegee is designed to wipe away the moisture under the PU . Goes easily with any kind of bumper, bonnet or bumper strip. Because of the softness of the touch, the squeegee pressure is lower and it does not damage the . The nice touch ensures an even drying process of the moisture and the .



Price per unit

The Pink Shaved Squeegee

150-PP3



- 10 cm wide

The Pink Shaved squeegee is a must-have for every PPF installer! This squeegee is ideal to install polyurethane s on bonnets, roofs, mudguards and doors. Because the squeegee is medium stiff, but has a thin soft edge, it follows the contours of the surface with the right pressure, thus removing the moisture under the . The squeegee tapers gradually at the edge, making it flexible.



Price per unit

The Small Shaped One - Soft but Firm

150-PP4



- 5 cm x 8 cm - Trapezium shape

This medium hard squeegee is ideal for convex and concave surfaces. Think of bumpers, mirrors, spoilers, headlights, etc. The trapezium shape allows you to use the squeegee on both sides. The sharp edge is very soft, so it follows every shape without problems and pulls the moisture out from under the very easily and nicely.gradually at the edge, making it flexible.



Price per unit

The Small Shaped One - Soft but Firm

150-PP5



- 5 cm x 8 cm - Trapezium shape

This medium hard squeegee is ideal for convex and concave surfaces. Think of bumpers, mirrors, spoilers, headlights, etc. The trapezium shape allows you to use the squeegee on both sides. The sharp edge is very soft, so it follows every shape without problems and pulls the moisture out from under the very easily and nicely.gradually at the edge, making it flexible.



Price per unit

SpeedWing Lime 11 cm - Hard**150-075**

- One side flat
- One side curved

The curved edge is designed to encourage a finger or bubble to disperse outward which reduces the chances of a crease.

*Price per unit***SpeedWing Lime 16 cm - Hard****150-076**

- One side flat
- One side curved

The curved edge is designed to encourage a finger or bubble to disperse outward which reduces the chances of a crease.

*Price per unit***SpeedWing Lime 21 cm - Hard****150-077**

- One side flat
- One side curved

The curved edge is designed to encourage a finger or bubble to disperse outward which reduces the chances of a crease.

*Price per unit***SpeedWing Lemon 11 cm - Medium****150-078**

- One side flat
- One side curved

The curved edge is designed to encourage a finger or bubble to disperse outward which reduces the chances of a crease.

*Price per unit***SpeedWing Lemon 16 cm - Medium****150-079**

- One side flat
- One side curved

The curved edge is designed to encourage a finger or bubble to disperse outward which reduces the chances of a crease.

*Price per unit***SpeedWing Cherry 11 cm - Medium****150-080**

- One side flat
- One side curved

The curved edge is designed to encourage a finger or bubble to disperse outward which reduces the chances of a crease.

*Price per unit***SpeedWing Cherry 16 cm - Medium****150-081**

- One side flat
- One side curved

The curved edge is designed to encourage a finger or bubble to disperse outward which reduces the chances of a crease.

Price per unit



Designed by Jacob Berg (NL)

- HANDLE FOR ALL TYPE OF TURBO SQUEEGEES
- 11 CM WIDE
- ALL FINGERS FREE FOR USE
- CREATES MORE POWER

Generate mega-power on your squeegee

WIN every BATTLE with window



Turbo squeegees are known worldwide. Every window tinter uses them. But how do you put a lot of power on this squeegee? With the special handle called The Knuckle, this is no longer a problem.

Made of super-strong plastic, The Knuckle is shaped like a boxing stirrup and fits perfectly in the hand. Maximum power is hence guaranteed. Simply slide a turborakel into the clamp on the front and The Knuckle is ready for use."

Do anything with the Knuckle in your hand.

The great thing is that you don't have to put The Knuckle aside to free up your hands to pick something up. While you have The Knuckle in your hand, you can also pick up window, peel off the protective sheet, spray the, place the, position it and then start squeegeeing with this Knuckle! All this while you still just had it in your hand. Bizarre but true. You just place your fingers through the eyes of the handle, and you have your hand free for use.



Choose which turbo squeegee you want to use in The Knuckle.



Slide a turbo squeegee into the slot.



Firm grip due to the shape of a punching bag.



QUICK TIPS

Compatible with:



150-003

Price per unit

Softline Yellow Turbo - Big Tube Squeegee - 12.5 cm

150-003BT

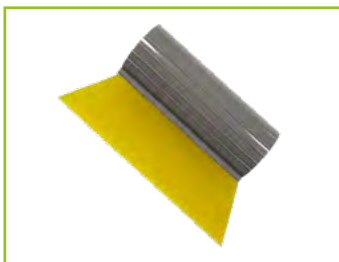

- Better grip
- Shaped corners
- Harder than the Softline Turbo Squeegee

This Yellow Turbo BIG TUBE polyurethane squeegee is harder than the standard yellow versions and less flexible. The handle is bigger and gives you a better grip, allowing you to apply more force and pressure while squeegeeing. Specially designed for wet applications.



Price per unit

Softline Green Turbo Squeegee - 9 cm

150-004GR

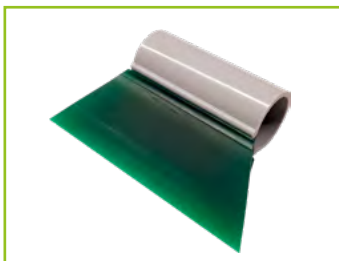

- Ultra soft and flexible; perfect for ppf installations
- Shaped corners

The smaller brother of the 150-003GR. This green polyurethane squeegee is soft and fits well in hand. Specially designed for wet mounts. Because of its enormous flexibility it is very suitable for touching up smooth s and s like PPF (paint protection s), cast s, window s etc. especially on round, curved and arched shapes.



Price per unit

Softline Green Turbo Squeegee - 12.5 cm

150-003GR

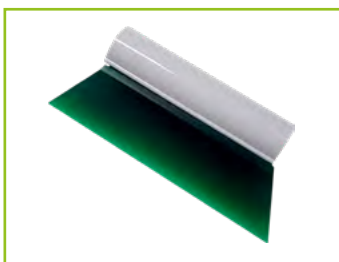

- Ultra soft and flexible; perfect for ppf installations
- Shaped corners

This green polyurethane squeegee is soft and fits well in hand. Specially designed for wet mounts. Due to its enormous flexibility, it is ideally suited for touching up smooth s and s such as PPF (paint protection s), cast s, window s, etc. on especially round, curved and arched shapes.



Price per unit

SOFTLINE TURBO SQUEEGEES



A must-have squeegee made of PU. The PU edge is firm yet very soft when used during wet application. It follows every contour of the surface you're working on, squeezing out water from between the and the surface.

Perfect for the first squeezes when positioning the , followed by the more stronger BlueMax squeegee (150-007), Hybrid squeegees(150-048) or The Orange Crush squeegees (150-050). Different versions are available.

Softline Yellow Turbo Squeegee - 9 cm

150-004

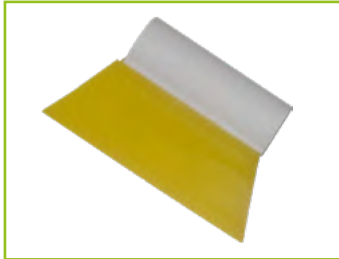

- Shaped corners

The YELLOW TURBO squeegee has a white plastic tube that provides good grip. The PU blade is firm yet very soft when used during wet application. It follows every contour of the surface you're working on. Perfect for the first squeezes when positioning the . The corners are shaped.

Width: 9 cm



Price per unit

Softline Yellow Turbo Squeegee - 14 cm

150-003



- Shaped corners

The YELLOW TURBO squeegee has a white plastic tube that provides good grip. The PU blade is firm yet very soft when used during wet application. It follows every contour of the surface you're working on. Perfect for the first squeezes when positioning the . The corners are shaped.

Width: 14 cm



Price per unit

Softline Yellow Turbo Squeegee - 24 cm

150-002



- Straight corners

The YELLOW TURBO squeegee has a white plastic tube that provides good grip. The PU blade is firm yet very soft when used during wet application. It follows every contour of the surface you're working on. Perfect for the first squeezes when positioning the . The corners are straight.

Width: 24 cm



Price per unit

Softline Yellow Turbo Squeegee - 48 cm

150-001



- Straight corners

The YELLOW TURBO squeegee has a white plastic tube that provides good grip. The PU blade is firm yet very soft when used during wet application. It follows every contour of the surface you're working on. Perfect for the first squeezes when positioning the . The corners are straight.

Width: 48 cm.



Price per unit



- Entirely of plastic
- Flexible but sturdy arm
- Width 20 cm (8")
- Perfect for mounting etch s and window s on flat glass



PERFECT SQUEEGEE FOR WET MOUNTING OF SELF-ADHESIVE VINYL AND WINDOW ON FLAT GLASS. THE ARM AND HANDLE ARE VERY STURDY AND STRONG BUT THE SQUEEGEE BLADE IS QUITE FLEXIBLE.

Price per unit

UNGER® Squeegee Set

300-RT01



- Entirely of plastic

Stainless window squeegee of the famous UNGER brand The best tool there is for cleaning flat glass windows to prepare them for application. Also very useful for wiping away most of the water after you have placed the wet on the glass.



Compatible with:



300-RTU-35-S

Price per unit

UNGER® Pro Hand grip

150-017



- 130 mm wide

Stainless steel handle from Unger, intended for the metal Unger glass squeegees. Fits all the Unger glass squeegees we offer. The back has four hooks that hold the rubber strip inside the squeegee.



Compatible with:



300-RTU-20

Price per unit

UNGER® Wiper + rubber blade

The stainless-steel wiper from Unger contains a (replaceable) soft rubber blade. Simply clip an Unger handle to this wiper and you have a high-quality squeegee for wiping windows clean and dry when cleaning. You can also use the Unger squeegee to position window directly when applying it and push out the first excess moisture from under the .

Replacement blades

Replaceable soft rubber blades for insertion into Unger stainless steel or aluminium wiper. Simply slide both in the Unger Hand Grip (150-017) and the rubber blade clamps into the wiper. Tip: turn your Unger into a power squeegee, by using a blue POWER MAX blade.

UNGER® Wiper 20 cm

300-RTU-20



- Stainless steel frame
- Soft rubber blade

20 cm

Price per unit

Rubber Blade 20 cm

300-RTU-20-S



20 cm

Price per unit

POWER MAX Blade 20 cm

300-PM20-S



20 cm

POWER MAX

Price per unit

Rubber Blade 35 cm

300-RTU-35-S



35 cm

Price per unit



- Softer than the Yellow Contour, harder than the Green Contour
- 15,5 cm x 8,5 cm

A unique squeegee specially shaped to easily push s into difficult corners. The SOTT variant is in between the original Yellow Contour and Green Contour in terms of stiffness. A must have.



Price per unit

The Contour Yellow

150-031

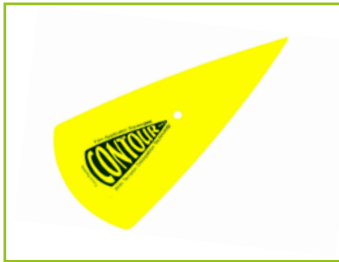

- Medium soft

Smooth and flexible squeegee for perfect application of window and car wap in hard to access areas. This squeegee allows the to be applied evenly under rubber sealing strips without damaging the . This is an invaluable squeegee for the true professional.



Price per unit

The Contour Green

150-032



- Soft and more flexible

Smooth and flexible squeegee for perfect application of window and car wap in hard to access areas. This squeegee allows the to be applied evenly under rubber sealing strips without damaging the . This is an invaluable squeegee for the true professional.



Price per unit

The Contour Platinum

150-038



- Hard

The hardest textured Contour is a firmer card, with a built-in lubrication feature to prevent surface scratches.

Price per unit

The Hustler: The Ultimate 4 in 1 Squeegee SOTT

150-090



- **Cleverly designed shape to reach everywhere**
- **A 4 in 1 squeegee**

This cleverly shaped squeegee is a must for any installer. The different sides make it extremely practical to do various jobs with it. What can you do with this squeegee?.

The Hustler

**THE 4 IN 1 TOOL FOR EVERY WRAPPER,
INTERIOR INSTALLER & WINDOW TINTER**



QUICK TIPS

1. You can easily push wrap under rubbers of window frames or around roof racks without damaging the .
2. Also perfect for use as a cleaning tool. Wrap a cloth around the squeegee and use it to easily get into any small narrow place that area. It can also be used as a cutting guide squeegee for window frames.
3. After the window is installed, place the squeegee on the , at the top of the corner and against the rubbers of the window frame. Put your knife against the squeegee and slide both down in one movement. Result is a perfect straight cut.
4. Because the squeegee is smooth and solid, it is also good to use when installing rigid s such as interior s. You can use the rounded side of the Hustler to guide and turn the in a sharp corner without damaging the .

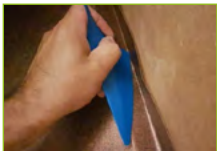

Price per unit

The Green Wing SOTT

150-082



- **Medium soft teflon, perfect for smooth squeegeeing**
- **Special angles and shapes**

The Green Wing is an indispensable squeegee for any professional installer. The squeegee is made of medium soft Teflon and is pliable so it can be used on both flat, convex and concave surfaces. Due to the four different edges and angles, it is possible to get any type of self-adhesive pushed into the most difficult places. The edges are not sharp so the will not be damaged.

Automotive window use:

This squeegee was actually developed to make it easier to push window in cars behind the door strip and squeegee the moisture there. Thanks to the thin design and round shape, this is easy to do without damaging the window .

Flat glass window use:

Use the GREEN WING as a cutting guide squeegee for window frames. After the window is installed, place the squeegee on the , at the top of the corner and against the rubbers of the window frame. Put your knife against the squeegee and slide both down in one movement. Result is a perfect straight cut.



Prepping car for wrap
Use the GREEN WING as a cleaning squeegee. Put your cleaning cloth around the squeegee and you can clean and degrease any small corner, kink or edge.

Price per unit

FOR INSTALLING OF:

- **WINDOW S (CARS AND BUILDINGS)**
- **CAR WRAPPING**
- **INTERIOR S**



- Seamless
- Perfect fit
- Stretch

Seamless application glove, made of elastic material. The white material helps you to check whether the surface and/or the vinyl is clean. Because of the perfect fit it gives you the necessary feeling that you need during your application work, especially when you deal with curved surfaces on cars. The glove is made of dust free material, so even touching the adhesive of the vinyl will not cause any residue to be left behind.



Perfect fit for applying you signs smoothly



The clean and dust free fabric will help you to do professional and clean application



Completely seamless with a perfect fit.



Because of the perfect fit and thin material, you keep the necessary feeling in your fingertips.



Available in 3 sizes:

400-252
400-253
400-254

Medium
Large
X-Large

Price per set
Price per set
Price per set

Little Willies - Set of 5 SOTT **NEW**



The replacement for the wrap glove

- Set of 5 pieces
- Ideal for pressing and guiding in trenches
- Prevents cutting your fingers
- Cut resistance level 5

An alternative to a complete wrap glove.

"Wrapping gloves are now fully established. But why should the WHOLE hand be covered with fabric if you often only use your fingers to push the into the channels and kinks? Also: using a glove to grip the 's adhesive layer is not always wise; fibers and dust can stick to the adhesive layer from the glove. And we don't want that.

Simply place the Little Willies on just a few fingers. Use these fingers to press on the and the other to grip the and adhesive layer. Pretty as it can be. Comes in one size; elastic fabric

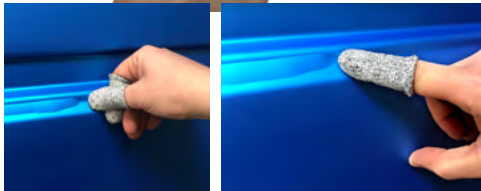

Stick, wrap, install and cut without getting injured. This is possible with the Little Willies from SOTT as they are made of cut-resistant fabric and therefore meet the ASTM/ANSI test: Cut Level 5. So a quick cut on your fingers is not an option.

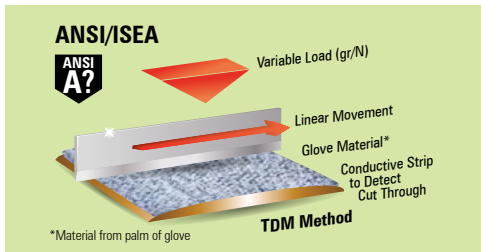

	ANSI/ISEA 105 (2005/2011)	ANSI/ISEA 105 (2016)	
Old Cut Level Rating	Weight (grams) needed to cut thru material**: ASTM F1790-97 or ASTM F1790-05	Weight (grams) needed to cut thru material**: ASTM F2992/F2992M-15 (20 mm of blade travel)	NEW Cut Level Rating
0	< 200	n/a	n/a
1	≥ 200	≥ 200	n/a
2	≥ 500	≥ 500	n/a
3	≥ 1000	≥ 1000	n/a
4	≥ 1500	≥ 1500	n/a
5	≥ 3500	≥ 2200	n/a
n/a	n/a	≥ 3000	n/a
n/a	n/a	≥ 4000	n/a
n/a	n/a	≥ 5000	n/a
n/a	n/a	≥ 6000	n/a

**25mm (1.0 in.) of blade travel - ASTM F1790-97
20mm (0.8 in.) of blade travel - ASTM F1790-05

** 20mm (0.8 in.) of blade travel

Price for 5 pieces



- Meets the ASTM/ANSI test: Cut level 5
- Smooth and tightly woven
- Set of 1 pair

Every installer knows the problem: accidentally cutting your hand or fingers. When large sheets of , cardboard or plastic panels have to be cut, there is a risk of accidentally cutting your fingers. This can be avoided using the ANTI-CUT Glove. This glove is woven with a smooth fibre that prevents sharp objects from passing through it.



Another ideal application is to use when deforming window on car windows. With its dense and smooth texture, the glove helps, positions and rubs away creases during heat-shrinking.

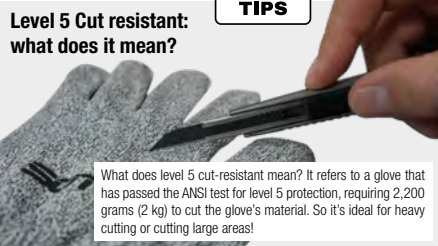
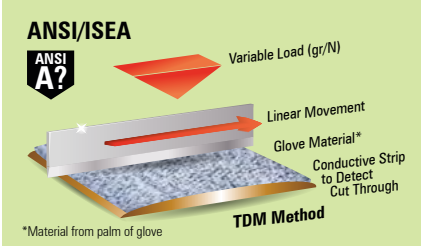

ANSI/ISEA 105 (2005/2011)		ANSI/ISEA 105 (2016)	
Old Cut Level Rating	Weight (grams) needed to cut thru material*: ASTM F1790-97 or ASTM F1790-05	Weight (grams) needed to cut thru material**: ASTM F2992/F2992M-15 (20 mm of blade travel)	NEW Cut Level Rating
0	< 200	n/a	n/a
1	≥ 200	≥ 200	n/a
2	≥ 500	≥ 500	n/a
3	≥ 1000	≥ 1000	n/a
4	≥ 1500	≥ 1500	n/a
5	≥ 3500	≥ 2200	n/a
n/a	n/a	≥ 3000	n/a
n/a	n/a	≥ 4000	n/a
n/a	n/a	≥ 5000	n/a
n/a	n/a	≥ 6000	n/a

*25mm (1.0 in.) of blade travel - ASTM F1790-97
20mm (0.8 in.) of blade travel - ASTM F1790-05

** 20mm (0.8 in.) of blade travel

Price per unit

The Factotum II **SOTT**



- The solution for small corners, holes, seams and cracks
- Unbreakable material

Every mechanic knows it: mounting self-adhesive in places that are hard to reach. The Factotum-II is a handy mini oval with two usable sides. It guides every in the smallest corner or kink, without destroying the while pressing. The smooth rounded corners give you the perfect opportunity to guide the to where you want it.

Medium stiff and unbreakable.



For installing window :

Easily install your window between window rubbers, door frames, or in a corner between the rear shelf by using the Factotum-II to direct the to your desired location.



For installing interior :

Mounting these s is a precise job. Every edge, seam and kink has to be perfect. Especially in corners and around small objects it is nice when you can finish and press the edges with precision tools. This is what the Factotum-II is for.



For installing wrapping :

Installing wrapping between headlights, window frames, door handles and taillights is precision work. Small tools are a godsend. The Factotum-II gives you the possibility to guide the in the corner and press it on places you normally cannot reach.

Price per unit

EZ Reach ULa Platinum - Medium

150-070



The platinum version offers a hard card texture with internal lubrication technology that helps prevent point-of-contact scratching.

Price per unit

EZ Reach ULa Gold - Soft

150-071



The EZ Reach Ultra gold version has a flex-firm rating that works wonders.

Price per unit

EZ Wing Lime - Soft

150-074



Super soft and flexible but stiff in the middle. The EZ Wing has a slightly curved main edge. The curved edge is designed to enable the tool to encourage a finger or bubble to disperse outward, which reduces the likelihood of a crease.

Price per unit

Gold EZ Squeegee

150-029



- **Medium hard**

Smooth and flexible squeegee, perfect for applying carwrap and automotive window in hard to reach areas and corners. Medium hardness.



Price per unit

Triangle Reach Squeegee set of 3

150-096

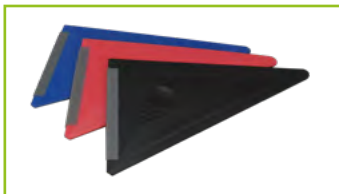

- **3 different hardnesses**
- **Rubber strip on the short side**

Interesting and super handy. This set of three squeegees is an ideal solution for every car window installer. The squeegees have different edges and therefore different functions. For example, the round tip is great for guiding window around difficult corners and between tight-fitting rubbers or strips.

The short side has a rubber strip, which provides excellent pressure to repel moisture under the . The shortened squeegee tip prevents the from tearing at corners during squeegeeing. Set of 3 types



Price per set

Platinum Silver EZ Squeegee

150-028



- **Soft**

Same product as above but softer.



Price per unit

Teflon Yellow Squeegee

150-027



Very soft and flexible Yellow Teflon squeegee. Perfect for use on large, curved windshields thanks to its 15 cm width. Won't scratch glass.

Price per unit

Diamond Tip Yellow

150-030



An essential tool for applying vinyl in hard to reach areas, because of the special design and sharp edges of this squeegee. Won't scratch glass

Price per unit

Hau Tool Black Squeegee - Medium Hard

150-084



Black plastic squeegee in parallelogram shape of German manufacture. This black version forms itself nicely to the shape of the surface while maintaining good pressure on the edge. Good to use as a squeegee for small narrow corners and slots but also for large surfaces. Does not scratch window s. The squeegee edges are 15 and 8 cm.

The light structure of the blade prevents it from slipping out of your hand when you work with moisture. The does not stick to the squeegee either.



The red version 150-085 is a bit softer and more flexible.

Price per unit

Hau Tool Red Squeegee - Medium Soft

150-085



Red plastic squeegee in parallelogram shape of German manufacture. This red version is a bit softer than the black version and therefore it follows the shape of curved surfaces just a little bit easier. It can be used as a squeegee for small, narrow corners and slits as well as for large surfaces. Does not scratch window s. The squeegee edges are 15 and 8 cm. The light structure of the blade prevents it from slipping out of your hand when you work with moisture. The does not stick to the squeegee either.



The black version 150-084 is slightly stiffer.

Price per unit

The Plow

150-011

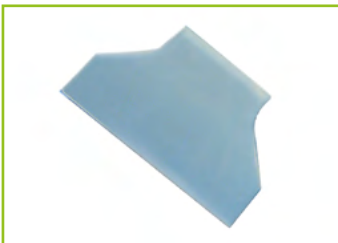

Flexible squeegee for curved surfaces, such as windshields. Adapts itself to each surface.

Price per unit

The Red Devil

150-013



Very thin (1 mm!) and flexible squeegee for positioning and applying window on side windows and for reaching sharply angled corners.

Price per unit

Grip-N-Glide Orange - Soft

150-068



- For paint protection, vinyl graphics and car wrap s

The Grip-n-Glide features a sturdy construction with interchangeable blades. The blades conveniently and securely snap in and out of the uniquely shaped ergonomic body. The body is then covered in an ultra-comfortable handgrip that has a deep surface texture making this squeegee easy to use in wet or dry environments.



Replacement blade:

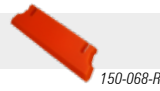

150-068-R

Price per unit

Grip-N-Glide Yellow - Medium

150-069



- For window installation

The Grip-n-Glide features a sturdy construction with interchangeable blades. The blades conveniently and securely snap in and out of the uniquely shaped ergonomic body. The body is then covered in an ultra-comfortable handgrip that has a deep surface texture making this squeegee easy to use in wet or dry environments.



Replacement blade:



150-069-R

Price per unit

Power Stroke - 15 cm

150-005



- Flexible

An original handheld molded Squeegee, ergonomical designed to fit comfortably in your hand. It measures 15 cm from tip to tip, with a ridged grip area that fits your hand perfectly to reduce fatigue.

Price per unit

Little Foot Blue - Soft

150-072



- Soft

The Little Foot Blue fits comfortably in your hand, and features an angled, long-reach tip that gets behind gaskets and rubber seals quickly and easily. Measuring about 15 cm along the usable edge, Little Foot's pointed tip lets you squeegee in tight spaces while keeping a firm grip on the tool.

Price per unit

Little Foot Red - Medium

150-073



- Medium firm

The Little Foot Red fits comfortably in your hand, and features an angled, long-reach tip that gets behind gaskets and rubber seals quickly and easily. Measuring about 15 cm along the usable edge, Little Foot's pointed tip lets you squeegee in tight spaces while keeping a firm grip on the tool.

Price per unit

Black Edge Squeegee

150-019

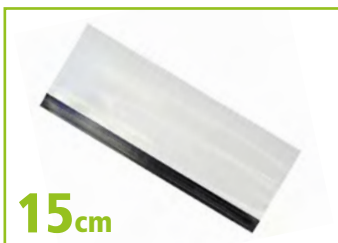

- Medium firm

This flat rigid plastic squeegee has a black rubber medium hard blade to pull moisture out from under window s. The white body is thin but ergonomically shaped, so your fingers have enough grip to apply force.

Price per unit

The Slammer

150-010



Stiff, smooth plastic squeegee for automotive windows. This squeegee has been specially designed to deal with hard-to-reach areas, such as the glass surface under the rubber rim. The sturdy handle allows for a good grip. Won't scratch the window.

Price per unit

The Edge

400-003



Stiff and smooth big squeegee to push back the rubbers in the door of cars. Makes tinting the windows of cars under the rubbers much easier.



Price per unit

Tail Fin Green - Soft

150-022



- Designed for installation behind brake lights - soft and flexible
- Softer than the yellow version

You know the problem: that third brake light at the bottom-center of the back window. This special tool is designed to make installing window around the third brake light easier. It pushes out moisture -and keeps it out with pressure that holds down the edges behind that bothersome third brake light. It has an arched, curved body that gets behind the brake light to apply the constant pressure required to keep moisture from seeping back, thus allowing the adhesive to grab. Designed with two holes in the body of the tool for a better grip.

Price per unit

Tail Fin Green - Soft

150-023



- Designed for installation behind brake lights - soft and flexible
- Stiffer than the green version

You know the problem: that third brake light at the bottom-center of the back window. This special tool is designed to make installing window around the third brake light easier. It pushes out moisture -and keeps it out with pressure that holds down the edges behind that bothersome third brake light. It has an arched, curved body that gets behind the brake light to apply the constant pressure required to keep moisture from seeping back, thus allowing the adhesive to grab. Designed with two holes in the body of the tool for a better grip.

Price per unit

Smart Card

150-018

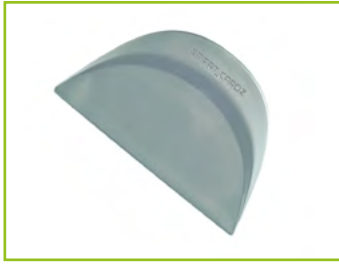

A contemporary version of the Teflon squeegee - but they're better, because they are 25 % wider and their tapered tip, comfortable grip, dynamic flex and thin squeegee edge is sure to make easy work of the toughest installations.

Price per unit

Gator Blade I - Red

300-016



Meet the ultimate plastic scraper. Our Gator Blade is as sharp as they come, but won't scratch or damage the . Safer and easier to use than razors, the Gator Blade is fast becoming the choice of installers, applicators and detailers everywhere. Perfect for cleaning glass, removing excess adhesive to scraping off decals.

Price per unit

The Chizler - Standard

150-034



Bigger than his little brother shown above. Will not damage defrost liners on the rear window



Price per unit

Lil' Chizler

150-033



Small and thin squeegee for small areas like the triangular windows, or for squeezing small air bubbles away. Also perfect to remove dirt and old adhesives from the rear window. Will not damage defrost liners on the rear window.



Price per unit

The Bulldozer I - Car Tinting Applications

150-020



- With one hand tied behind your back you will be able to:
- Squeegee behind speakers, 3rd brake light, low-lying rear windcreens.
- No more scraped knuckles.

Specially designed plastic squeegee, extra large and extra wide. The design allows you to apply firmly in those hard to reach areas. The squeegee adapts itself perfectly to the curve of the window. The end of the blade is fitted with a rubber strip to remove the last, tiny drops of moisture.



QUICK TIPS

Size: 39 cm x 15 cm

Price per unit

The Bulldozer II - Flat Glass Applications

150-021



- With one hand tied behind your back you will be able to:
- Squeegee behind radiators, desks, semi-exposed pipes and the like.
- No more stress.

Specially designed plastic squeegee, extra tall and extra wide. The design allows you to apply firmly in those hard to reach areas. The squeegee adapts itself perfectly to the curve of the window. The end of the blade is fitted with a rubber strip to rinse off the last, tiny drops of moisture.



QUICK TIPS

Size: 39 cm x 15 cm

Price per unit

Yellow Reach Wing 43 cm *NEW*

150-083

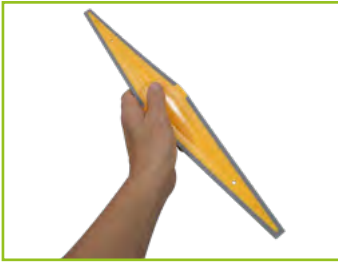

- Especially for hard-to-reach areas
- Tough, flexible and unbreakable

We have all known the frustration of hidden spots or restricted areas where you could hardly squeegee the water out. The Yellow Reach Wing is a squeegee designed especially for window , to apply the best possible pressure in small hard-to-reach areas. The slightly curved shape makes the squeegee sturdy and stable for applying pressure.

There are ridges on the bottom for better grip when the squeegee is wet. The grey rubber edges allow moisture under the window to escape."



Price per unit

The Conquistador

150-008



Specially designed squeegee for the installation of window in hard to reach areas. It's ergonomic design is perfect for applying in tight & sharp angled corners.

Price per unit

The Conquerer - The Original One

150-008S



Nothing beats the original Conquerer. This squeegee is the favorite per excellence with experienced car tinters because it is the tool of choice to mount window nicely in the dot matrix (grids).



QUICK TIPS

What is the difference with the other versions?
The rubber strip on the squeegee does not melt at high temperatures.

Price per unit

The Titan

150-046



- Ultimate versatility

This special squeegee solves the two main problems experienced during the application of window on to convex rear windshields and side windows.



1. Its long, sturdy but flexible form makes it the perfect squeegee for applying to very deep and low-lying rear windshields.



2. The profile variations at the back of the squeegee allows it to work the window in to corners and between the window seals in a number of different ways. Manufactured from sturdy, flexible and unbreakable plastic.



QUICK TIPS

Size: 38 cm x 8 cm

Price per unit

The Yellow Quickfoot

150-026

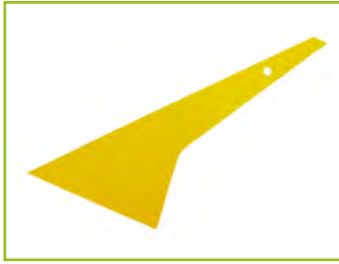

- Medium hard

Stiff, smooth plastic squeegee for applying automotive window s in hard to reach areas. This squeegee fits into a variety of differently angled corners, and its long narrow end is perfect for pushing back rubbers.

Price per unit

Quickfoot Blue - Soft

150-180



- Flexible

When you need a stiff squeegee with a handle for jobs that require medium reach, Quick Foot is the perfect »in-between« tool. Quick Foot is slim and trim like Slim Foot, but has a shorter, unwrapped handle so it fits more easily in your tool apron. This economically priced hybrid gives you a range of flex rating options to meet a variety of applications.

Price per unit

The Slimfoot

150-170



- Squeegee for hard to reach areas - 36 cm long - 15 cm wide

THE SLIMFOOT: Special thin, long squeegee, for example for use with flat rear windows, when squeezing is difficult.

Price per unit

5 - Way Tool

150-035



Helper for holding window adhesive taut on windows at edges and corners during cutting. This grey version is made of soft pliable plastic and has rounded corners, so that the window will not damage when slid or placed in a corner.

These are the 5 possibilities of using the 5-way tool:

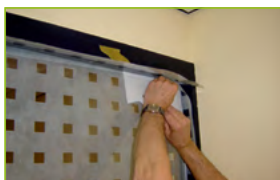

A rounded short bevel that allows foil to be carefully pushed into a difficult corner.

A short bevel with a 10 cm long straight edge that enables this side to be so used as a regular squeegee.

A 90° angle, where the can be cut directly on both edges.

A 26 cm straight edge that can be used as a cutting ruler and guide.

A large diagonal angle (80°), so that one side can already be cut while on the other side the may still need to be squeegeed to the edge.

Price per unit

Go Doctor Red - Soft

150-060



- Soft

The Go Doctor Red window squeegee features an "i-beam" handle construction which fits comfortably in your hand. The design provides greater efficiency and less fatigue. This Red Go Doctor blade is the softest of the three blades and is perfect for thinner window s and paint protection s.



QUICK TIPS

Replacement blade:



150-060-R

Price per unit

Go Doctor Yellow - Medium

150-062



- Medium Firm

The Go Doctor Yellow window squeegee features an "i-beam" handle construction which fits comfortably in your hand. This design provides greater efficiency and less fatigue.

This Yellow Go Doctor blade is the medium-firm blade and is perfect for window s of all kinds, paint protection , auto wrap installations and vinyl graphics.



QUICK TIPS

Replacement blade:



150-062-R

Price per unit

Go Doctor Blue - Hard

150-061



- Firm

The Go Doctor Blue window squeegee features an "i-beam" handle construction which fits comfortably in your hand. This and is perfect for high performance and thicker s. This Blue Go Doctor blade is the firmest of the three blades and is perfect for high performance and thicker s.



QUICK TIPS

Replacement blade:



150-061-R

Price per unit

Stroke Doctor - Firm

150-059



- 17.5 cm wide
- Soft touch grip

Developed for wipe out hard to reach areas during installation.

Perfect for squeegeeing out window at the bottom of a rear deck or windshield area.



QUICK TIPS

Replacement blade:



150-059-R

Price per unit

The Side Swiper - 15 cm

150-063



- 1 Optimal pressure on the tip
- Ideal for difficult to reach places

The SIDE SWIPER is a unique squeegee designed for installing window s in difficult to reach places. Thanks to its special shape it has many advantages. Handle: This makes it easier to get your hand and squeegee into narrow and difficult places, such as sloping car rear windows. Your hand lies further behind the squeegee, which extends your reach.

Body: the body of the squeegee is made of sturdy plastic and allows you to apply force. The body is completely rounded and gets smaller to the tip, so it cannot damage the . Rubber strip: the (replaceable) strip works like a squeegee and because of the considerable force you can put on the tip, it is very easy to push away all the remaining moisture at that spot.



Price per unit



BIG TURBO squeegees

With a larger diameter and black rubber strip, the Big Turbo is an ideal squeegee for quick installations of windows on glass in buildings. The larger tube lies better and firmer in your hand so that you can apply more force without in, or tiring your wrists. In short: a good addition to your toolbox.

Large diameter handle: 4 cm
Better grip in your hand so less fatigue while squeezing.

Big Mini Turbo Squeegee - 10 cm

150-113

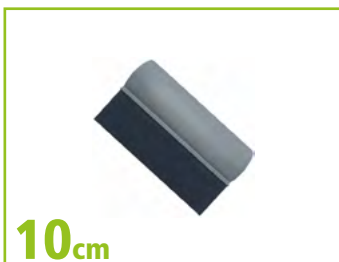

- Width: 10 cm

This Big Turbo Squeegee has the same large diameter of the tube as all of his wider brothers. Due to its narrow width of 10cm, this squeegee is ideal for fitting in window at the edges of rebates. This squeegee is also often used as a cleaning squeegee to pull away and remove any dirt in the water at the sides of the window.



Price per unit

Big Turbo Squeegee - 17 cm

150-112

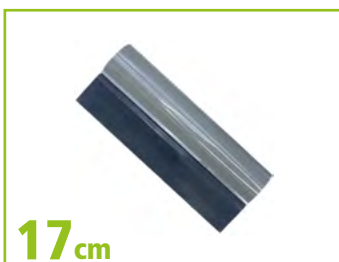

- Width: 17 cm

The Big Turbo Squeegee is the squeegee to apply large areas in one go. The advantage of the Big Turbo squeegee is the larger diameter of the tube with which it is held. Therefore, you can apply more force without tiring your hand and wrist. The black rubber blade is medium stiff. On the sides of the tube are ridges for extra grip which prevent the tube from slipping and sliding in your hand.



Price per unit

Big Turbo Squeegee - 23 cm

150-111



- Width: 23 cm

The Big Turbo Squeegee is the ideal squeegee to apply large areas in one go. The advantage of the Big Turbo squeegee is the larger diameter of the tube with which it is held. Therefore, you can apply more force without tiring your hand and wrist. The black rubber blade is medium stiff. On the sides of the tube are ridges for extra grip which prevent the tube from sliding and slipping in your hand.



Price per unit

Big Turbo Squeegee - 71 cm

150-110



- Width: 71 cm

The Big Turbo Squeegee is the ideal squeegee to apply large areas in one go. The advantage of the Big Turbo squeegee is the larger diameter of the tube with which it is held. Therefore, you can apply more force without tiring your hand and wrist. The black rubber blade is medium stiff.



Price per unit

The Blue Max - 13 cm

150-007



- Soft but resilient

The Blue Max is the ultimate squeegee for wet applications, since no other squeegee can rival it for removing moisture under the . Perfectly use for thick and stiff s, like safety s, solar windows and laminated digital print s.



QUICK TIPS

Use with:



Price per unit

The Blue Max - 20 cm

NEW

150-091

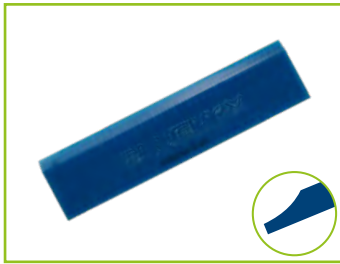

- The big brother of the 13 cm version - Soft yet hard-wearing

The Blue Max is the best-selling squeegee for wet application! This polyurethane squeegee effortlessly pushes or pulls the moisture under any out. It is especially suitable for thick, hard and stiff s. Combined with the right grip, you have a perfect, durable squeegee for multiple applications."



QUICK TIPS

Use with:



Price per unit

The SOTT® Max - 13 cm SOTT

150-006

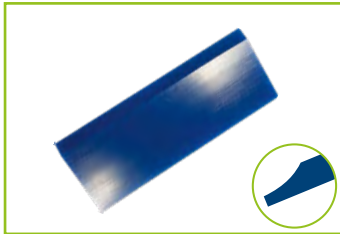

- Soft but resilient

The SOTT Max is by far one of the most important squeegees that a window tinter should have in his/her possession. Due to the combination of stiffness and flexibility, the squeegee gives an enormous pressure during squeegeeing, so moisture can often be pushed away at once. Especially for window s and safety s on flat glass.



QUICK TIPS

Use with:



Price per unit

The SOTT® Max Angle - 13 cm SOTT

150-006S



- 13 cm; trapezium shape

The SOTT MAX SHAPED corresponds to the standard SOTT MAX (150-042S) except for the shape on both sides. These run into a point, making it easier to push moisture away from edges and corners. Due to the combination of stiffness and flexibility, the squeegee gives an enormous pressure during squeegeeing, so moisture can often be pushed away in one go. Especially for hard window s and safety s on flat glass.



QUICK TIPS

Use with:



Price per unit

The Clear Max - 13 cm

150-012



- Softer than the Blue Max, but better for the rear windows.

The material used for the Clear Max is softer and so moves the moisture from beneath the much more efficiently; especially when the surface is slightly uneven as with rear windscreen demisters or dot matrix raster.



QUICK TIPS

Use with:



Price per unit

The Orange Crush 130 - 13 cm

150-050

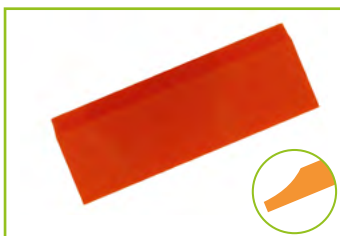

- 13 cm (5") wide; harder than the Blue Max

The Orange Crush is a polyurethane squeegee that is slightly stiffer than the Blue Max. This makes it the perfect all-rounder. This squeegee is ideal for removing moisture from beneath a variety of s including window , polyester laminate, thick safety s and even s covered in application tape.



QUICK TIPS

Use with:



Price per unit

THE HYBRID - A multitalent: 2 Squeegees in One

- A multitalent: 2 squeegees in one
- Blue side: medium hard, orange side: soft
- In 2 widths available

This unique polyurethane squeegee consists of two layers, each with a different hardness. The orange side is softer than the blue side. The squeegee angles on either side are different as well, giving you full control over the right amount of pressure during installation.

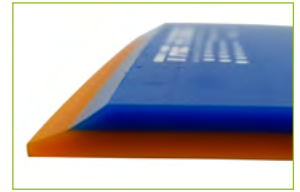
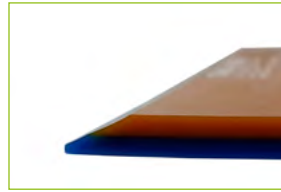
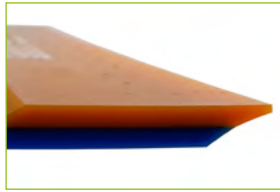

13 cm wide

150-048

20 cm wide

150-049



Use with:



Price per unit



Use with:



Price per unit

The Orange Crush 200 - 20 cm

150-051



- 20,5 cm (8") wide; harder than the Blue Max

The Orange Crush 200 is the same as the 130 version, only wider, making it the ideal choice for larger areas of .



Use with:



Price per unit

Woody Grip Squeegee - Ultimate Tool for Safety s

150-054



- Wooden handle for 2 hands at the same time
- The Ultimate tool for Safety s

The WOODY is a block squeegee where pressure can be applied with two hands at the same time. The advantage is that one does not have to squeegee over the same spot several times, as the pressure is so high that only one or two strokes are necessary. This squeegee makes working faster and therefore more efficient. This is indispensable if you need to apply window s to many large windows.

Now you can install safety window s thicker than 200 microns with ease without the risk of leaving a lot of water underneath.



Replacement blade:



150-054R

Price per unit

Pressure Squeegee for Woody Grip

150-054R



- 5 cm x 20 cm

This block-shaped pressure squeegee is intended to be used in the WOODY grip. The sturdy nylon ensures the right pressure when installing window s on large surfaces.



Replacement squeegee for Woody Grip



150-054

Price per unit

High performance hand grips FOR MORE POWER

If you want a perfect installation of window s, these hand grips are your best friend. On this page you will find the small versions. Simply insert the desired squeegee into one of these hand grips and you're ready to get your job done!

SOTT® - 5 Hand Grip SOTT

150-042S



Special handle, made of high-quality plastic, for clamping special squeegees. These handles have a better and longer grip, so they can be held securely without getting tired of squeegeeing. In addition, it is extra comfortable because the grip area is covered with a non-slip foam. Due to the curved shape and the special smooth plastic, the handle will not touch or damage the when a lot of pressure is applied to it. This is the handle for soft squeegees, to squeeze s with the wet method. Particularly suitable for thick and hard s such as security s and window s.



Price per unit

SOTT® - 5 Short Grip Handle - Extra Short SOTT

150-042SM



- Short handle: 8 cm

Same as 150-042S Hand Grip except shorter handle. This strong heavy-duty handle is ideal for use in small areas where space is limited. Often the handle is too long and you can't rake properly because the back piece gets stuck. With a handle length of only 8 cm, it does not stick out from under your hand and you can squeeze it perfectly in small spaces while still being able to use force to push moisture out from under the . Made of strong nylon.



Price per unit

Fusion - 5 Hand Grip

150-042



FUSION hand grips offer an improved and extended grip reducing fatigue from squeegee work during those long applications. Extra comfort is provided by the anti-slip foam coating on the actual gripping area. The curved form of this special smooth plastic hand grip prevents it from coming in to contact with when extra pressure is applied, so any risk of damage to your work is eliminated. This is the ultimate hand grip for squeegees used for the wet application of . Perfect for use with thick and hard s, such as security and window .



Price per unit



QUICK TIPS

Perfectly combine with the following squeegees:

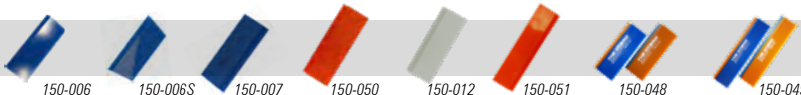

Short - 13 Hand Grip

150-039



- Rubber anti-slip handle

The SHORT-13 is an ideal handle for installing window s in environments where space is limited. Because the handle is only 10 cm short, it can easily be used in any angle and environment. Think of rear windows of cars, side rear windows in compact or hatchback models, etc. The rubber handle prevents slipping in situations when hands are wet.

The plastic squeegee is simply clamped into the jaws (note that it is not secured with screws). Intended for squeegees of 13 cm width.



QUICK TIPS

Perfectly combine with the following squeegees:

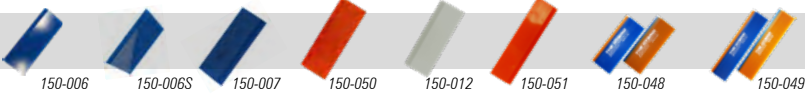

150-006 150-006S 150-007 150-050 150-012 150-051 150-048 150-049

Price per unit

Fusion - 8 Hand Grip

150-043



- 200 mm (8") wide; indestructible plastic

An exceptional hand grip, extra wide, manufactured from high quality, unbreakable plastic for use with special squeegees. FUSION hand grips offer an improved and extended grip reducing fatigue from squeegee work during those long applications. Extra comfort is provided by the anti-slip foam coating on the actual gripping area. The curved form of this special smooth plastic hand grip prevents it from coming in to contact with when extra pressure is applied, so any risk of damage to your work is eliminated.

This is the ultimate hand grip for squeegees used for the wet application of . Perfect for use with thick and hard foils, such as security and window .



QUICK TIPS

Perfectly combine with the following squeegees:

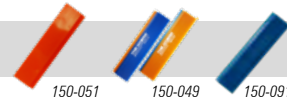

150-051 150-049 150-091

Price per unit

Fusion Stretch Handle - Extra Long Grip

- Extra long grip: 40 cm (16")
- Available in 2 widths: 130 mm (5") and 200 mm (8")
- Indestructible plastic

Unique squeegee holder as the standard Fusion-series, but with an extra long stainless steel grip. Because the grip is no less than 40 cm (16") long, an enormous amount of pressure can be applied when squeegeeing window s. This makes installing less tedious: ideal for large windows.

Example:
FUSION Stretch grip
with squeegee

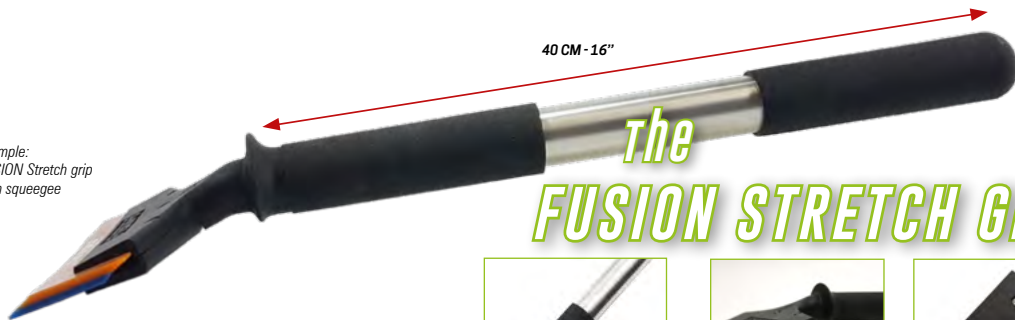

Fusion - 5 Stretch Handle 13

150-042L



Use with:



150-006 150-006S 150-007



150-050 150-012 150-048

Price per unit

Fusion - 8 Stretch Handle 20

150-043L



Use with:



150-051 150-049 150-091

Price per unit

Heavy Metal POWER HANDLE SQUEEGEES

Power Handles are ideal squeegees for the application of window s where extra pressure is needed during the pushing away of the moisture under the . These squeegees are used especially for thick window s such as security s.

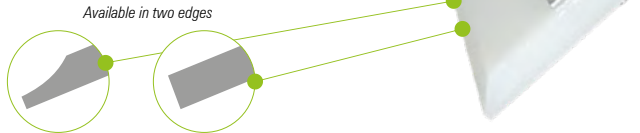

The metal frame provides stability and does not bend under pressure. The handle has small recesses so that wet hands still have a good grip on the handle. The replaceable nylon squeegee in the frame is medium stiff, available in different sizes and shapes.



Rubber grip with recesses avoids slipping when wet.



Strong curved metal neck for better angle.

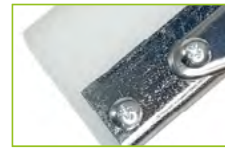

Metal body holds the squeegee in place.

Power Handle - 15S + Shaped Squeegee - 15 cm

150-055-S



- 15 cm
- Shaped squeegee blade- shaped squeegee blade

Power Handles are ideal squeegees for the application of window s where extra pressure is needed whilst pushing out the moisture from underneath the . These squeegees are especially made for thick window s such as security s. The metal frame provides stability and does not bend under pressure. The handle has small recesses so that wet hands still have a good grip on the handle. The replaceable nylon squeegee in the frame is medium stiff, has a length of 5 cm and has a 'shaped' front, which provides extra pressure during squeezing.



QUICK TIPS

Replaceable squeegee blades for this model are:



Comparable:

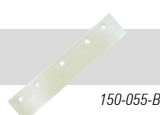

Price per unit

Power Handle - 15B + Block Squeegee - 15 cm

150-055-B



- 15 cm
- "Block-Shape" squeegee blade

Power Handles are ideal squeegees for the application of window s where extra pressure is needed whilst pushing out the moisture from underneath the . These squeegees are especially made for thick window s such as security s. The metal frame provides stability and does not bend under pressure. The handle has small recesses so that wet hands still have a good grip on the handle. The replaceable nylon squeegee in the frame is medium stiff, has a length of 3 cm and has a 'shaped' front, which provides extra pressure during squeezing.



QUICK TIPS

Replaceable squeegee blades for this model are:



Comparable:



Price per unit

Power Handle - 20B + "Block" Squeegee - 20 cm

150-056-B



- 20 cm
- "Block-Shape" squeegee blade

Power Handles are ideal squeegees for the application of windows where extra pressure is needed whilst pushing out the moisture from underneath the glass. These squeegees are especially made for thick windows such as security windows. The metal frame provides stability and does not bend under pressure. The handle has small recesses so that wet hands still have a good grip on the handle. The replaceable nylon squeegee in the frame is medium stiff, has a length of 3 cm and has a 'shaped' front, which provides extra pressure during squeegeeing.



QUICK TIPS

Replaceable squeegee blades for this model are:

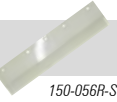

Comparable:

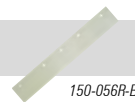

Price per unit

Squeegee Blades (Shaped) - for Power Handles

Shaped 15 cm

150-055R-S



Shaped front
Length: 4 cm
Width: 15 cm

This squeegee is designed for the PowerHandle-15S and 15B and can be easily mounted with 5 crosshead screws. This replaceable squeegee has a length of 4 cm and is therefore stiffer than for example the Blue Max or Orange Crush.

Price per unit

Shaped 20 cm

150-056R-S

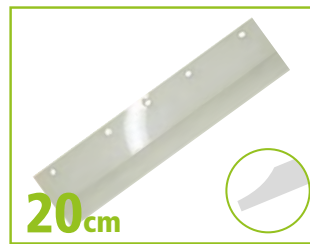

Shaped front
Length: 5 cm
Width: 20 cm

This squeegee is intended for the PowerHandle-20S and 20B and can be easily mounted using 5 crosshead screws. This replaceable squeegee has a length of 5 cm and is similar in rigidity to the Blue Max and Orange Crush.

Price per unit

Squeegee Blades (Block - Shape) - for Power Handles

Block - Shape 15 cm

150-055R-B



Block shape; extra rigid
Length: 3 cm
Width: 15 cm

This block-shaped squeegee is designed for the PowerHandle-15B and can be easily mounted with 5 crosshead screws. This block is very stiff because the length is only 3 cm. Ideal for extra pressure while squeegeeing.

Price per unit

Block - Shape 20 cm

150-056R-B

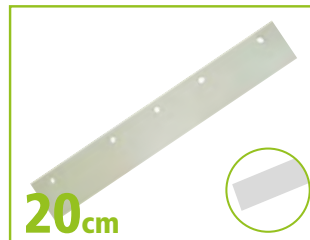

Block shape; extra rigid
Length: 3 cm
Width: 20 cm

This block-shaped squeegee is designed for the PowerHandle-20B and 20S and can be easily mounted with 5 crosshead screws. This block-shaped squeegee is very stiff because the length is only 3 cm. Ideal for extra pressure while squeegeeing.

Price per unit

SMART TOOLS

Intelligent tools for precise and fast installation of adhesive , even in the most complex installations. Thanks to our selection of innovative tools, you can apply your adhesive with greater ease and efficiency, for a perfect result.





- 2 Usable ends
- 2 Different-sized, rounded tips
- Metal guides

An ideal, nifty tool that helps install wraps and window s in hard-to-reach places. With two metal rounded tips in different sizes. The hexagonal body in the size of a pen is ultra handy, enabling you to control the tips to place and guide the into a particular spot. Durable plastic housing. Chrome-plated guides.



The Guider

the perfect tool for wrapping



Price per unit



- Press down in the smallest little areas
- 2 Different spoon positions
- Coated metal spoons

A must-have for every installer. This pen-style tool has two smooth metal spoons, each at a different angle. The spoons are flat to allow for to be expertly pressed down in otherwise unreachable places. Think of corners of car hoods, between rear lights and headlights, around grilles and door handles.



The Finisher *the solution for all holes and tight corners*



- PRESS UNDERNEATH RUBBERS OR WINDOW FRAMES, IN ANY HOLE OR CORNER.
- USEFUL IN ALL SITUATIONS.

Price per unit

SOTT® Wrap Tweezers SOTT



Handy tools for easy installation in hard to reach places

*win the fight
with small corners
and seams*



Each car wrapper and installer knows:
Pushing vinyl into small corners and cutting or wrapping around hard to reach areas can be quite a fight.

Specially designed for those tricky jobs are SOTT WRAP TWEEZERS.
3 different types of tweezers, each with its own purpose.
Now you master every little part on the car. Made of stainless steel.

Wrap Tweezer I

350-311



- Flat round nose
- Pulls the vinyl without destroying it

The stainless steel Wrap Tweezer-I has a special flat round nose that can hold the vinyl without the risk of tearing it while pulling it around corners. Cut the vinyl to size, heat it up and guide the vinyl around corners using the rounded tips. You're done.



Price per unit

Wrap Tweezer II

350-310



- Curved end, with point
- Extra thin and precise

Stainless steel tweezers with curved ends. Both points are sharp and fit well together so that vinyl can be easily picked up within cracks, seams, headlights and taillights, etc. Whenever there isn't anything else that can be used to get the vinyl in deep crevices of the car, the Wrap Tweezer-II is the solution.



Price per unit

SOTT® Tweezer SOTT

350-201



- Round shape, flat inner surface
- Sharp point

This coated pair of tweezers has a sharp pointed nose that curves on the outside while being flat on the inside. Ideal because now you can keep your grip when handling the vinyl while the outside, due to its curved shape, doesn't stick to the vinyl.



Price per unit



A challenge for all installers and sometimes (almost) impossible: placing and pressing down adhesive into small corners, gaps and holes. Wouldn't it be great if there was a tool for that! Oh yes, SOTT sells it. A pair of elongated squeegees that work together as a team to tackle any job. Here they are: The Squad.



These specially shaped squeegees are designed to apply any type of in hard-to-reach places. Whether it's for wrap , window or interior , thanks to their various special tips these tools can literally be used anywhere and in any situation. They are made of durable plastic so that they will not break, fray, buckle or curl easily. Several of the tips have sharp flat edges, to make it easier to push them into the smallest gaps. Despite this your will not be damaged because the tip material is smooth and shows no burrs. In short, a must-have for every installer who relies on fast and efficient work methods. Supplied as a set in its own case.



The smooth semicircular curved shape allows the installer to press down adhesive behind seams and edges. Ideal for spots that normally would be out of reach.



The curved tip tapers off and is ideal for pushing into corners and giving just that little bit of extra pressure to the rear side of edges, panels, doors etc.



Due to its smooth tapered shape, it is ideal for pushing all kinds of into any conceivable shape without damaging it.

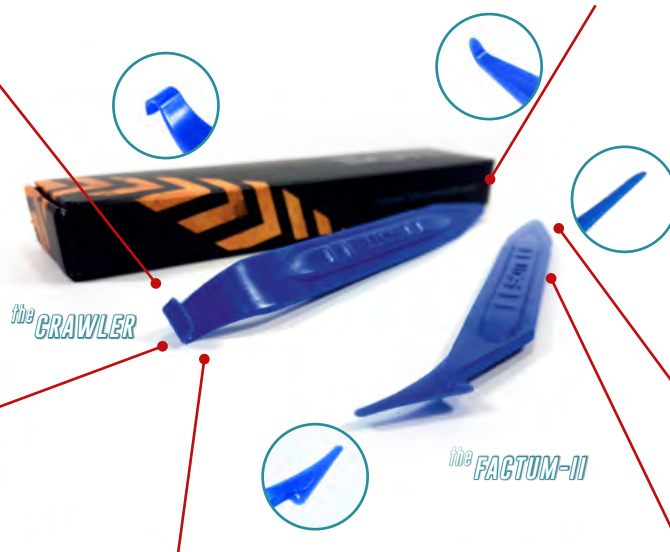

The tapered tail is quite stiff, yet flexible enough to push rubbers away from windows and other vehicle body parts. Because it is tapered and very smooth, it is a great tool for positioning windows before the water is squeegeed out from behind it.



The Factotum II saw some improvements over version I. The tip tapers off and has a sharper edge. It is stiff, yet flexible. This allows a lot of force to be applied when pushing into the smallest of channels and creases, but it won't break.



This is useful too: use the rounded tip for scraping off adhesive and small pieces when removing .

Mirror Wrap Tool Wood 38 cm **NEW**

350-200



- Wrap a mirror in the blink of an eye

This is a must-have for all wrappers! Every wrapper knows that wrapping a mirror is not that easy. If the mirror is not heated and stretched evenly, distortions, discolouration or glue streaks can occur. The Mirror Wrap Tool makes this all much easier.

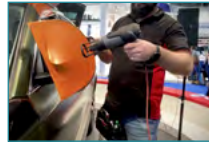

How to use:

1. Stick the tool over the arms of the Mirror Wrap Tool.
2. Heat the mirror evenly. And now push the mirror through the arms in one movement.
3. Viola, the mirror is evenly stretched over the convexity of the mirror.
4. Now carefully remove the tool from the arms and work the tool near the edges of the mirror as you would.
5. Just post heat and you're done.

- **HARD AND STURDY PLYWOOD**
- **18 MM THICK**
- **LARGE HANDLE**
- **SMOOTH FINISH TOP AND BOTTOM**

Price per unit

Emblem Removal Tool **NEW**

350-203



- Remove emblems without damaging them
- Aluminium handles
- Strong braided wire

Every car wrapper and ppf installer knows this problem: emblems on the bodywork that need to be neatly removed without damaging them. This handy tool makes this easy. A strong thin wire between two aluminium handles cuts the glue between the bodywork and the emblem without being damaged. Place the wire at the beginning of an emblem, against the glue (foam), pull the wire tight and now pull it back and forth. The wire slowly and neatly cuts through the glue layer. If necessary, you may also heat the emblem a little to soften the glue.



QUICK TIPS

Comes in handy storage box. Includes 1 extra wire.



Price per unit

Cutting Knife Holder for Carton Box

100-030



- Turn your foil box into a cutting dispenser
- Cut your foil directly from the box

Small aluminum knife holder that is easy to place on the edge of the foil box so you can cut your foil to a specific width directly from the box.

TIP: tape the beginning of your foil to a tube so that you have the same tension over the entire width when pulling up and cutting through.



QUICK TIPS

WE RECOMMEND these break-off blades are the best for this application:



120-BD-100A



120-SAB-10



How does it work?

1. Turn back the socket at the slot so that the slot is completely free.
2. Clamp a snap-off blade into the slot, sharp side down.
3. Tighten the socket so that the bolt clamps the break-off knife.
4. Now place the knife holder on the edge of the box, with the shear blade pointing inward, towards your foil inside the box.
5. Now pull your foil up a little and insert the foil through your knife blade.
6. Now gradually pull your foil up in one smooth motion, as far as you like.

Price per unit

SOTT® Stainless Steel Hook **SOTT**

- Stainless steel
- Length: 17 cm and 23 cm

Use this stainless steel hook to keep bonnets and tailgates of cars slightly open. Ideal for window tinters, car wrappers and PPF installers.

17 cm

400-075



17cm

Now a bonnet or tailgate doesn't keep falling into the lock. Now the installer can easily reach the edges to finish the

Price per unit

23 cm

400-076



23cm

Now a bonnet or tailgate doesn't keep falling into the lock. Now the installer can easily reach the edges to finish the

Price per unit

Weeding Tool

350-202



- Special domed point

This clever, pen-like gadget has a rounded tip, which makes it easier to peel s without damaging the liner or backing paper.

Price per unit

SOTT® Air Release Tool - Aluminium Body SOTT

100-NP-1



- With retractable needle
- Aluminium version
- Professional quality

The SOTT AIR RELEASE TOOL has the size of a pen and lies well in the hand thanks to its thickness and non-slip front.

The ultra thin and sharp needle gives you the ability to accurately and very locally prick away air bubbles. The needle is by means of an internal spring to pull so that this bubble piercer safely stored. The needle is not replaceable.



Price per unit

Air Release Tool - Black

100-NP-2



- Ballpoint model
- With retractable needle

Air release tool in ballpoint shape with razor-sharp needle inside. Simply click on the back and the needle comes out of the shaft.

Click again and the needle will retract. Ideal for mounts where air bubbles have formed between the and substrate. Delivered in luxury box. The needle is not replaceable.



Price per unit

Injection Needle - Ultra - Thin .45

350-221



- 0.45 mm thick
- Bevelled tip for invisible penetration

By using this syringe together with the 350-220 syringe you have the solution to suck out moisture bubbles under paint protection s (PPF).

How does it work?

Pierce the needle horizontally in the bubble and suck the water into the syringe. Take the needle out of the vacuumed bubble and press the small hole closed with your thumb. Within a few hours, the hole will be invisible and 'healed'. Viola, your perfect assembly is ready!



Price per unit

Injection Syringe - 10 ml

350-220



The ultimate solution! A Must-have for every PPF installer!

Every PPF (paint protection) installer knows it: somewhere in the middle of the bonnet a big water bubble. What can you do about it? Pull off the complete and start all over again? Not at all. You don't have to! Just use a syringe with an ultrathin needle to make an invisible hole and suck the moisture out of the bubble!

How does it work?

Pierce the needle horizontally in the bubble and suck the water into the syringe. Take the needle out of the vacuumed bubble and press the small hole closed with your thumb. Within a few hours, the hole will be invisible and 'healed'. Viola, your perfect assembly is ready!



Price per unit

INSTALLATION TOOLS

A complete range of intelligent tools designed to make the installation of adhesive on glass surfaces quick and easy. Professional-grade tools for fast, accurate installation that will save you time on your projects.



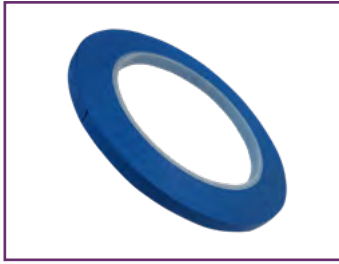

- Define cutting lines before install ppf
- Define working lines* on any vehicle
- Position lettering along a predetermined line
- Create a flexible ruler for cutting purposes

This 6 mm (25") plastic tape is a revelation for every fitter. Easy to stretch and shape, does not leave adhesive residue. Quite thick, so doesn't tear or break easily. Cutting and Contour Tape is ideal for:

QUICK TIPS Size: 6 mm x 55 m



Defining working lines:

Define working lines on curved or wedge shaped cars. This will create a fixed working line that will follow the form of the car. Use this line as a reference for positioning your sign to ensure that it is visually correct.



Establish cutting lines:

If needs to be cut to follow a desired form then Cutting and Contour Tape is the ideal solution. First apply the , use the tape to create the desired form, and then simply cut carefully along the tape. The red and blue panel shown on the photo can be cut entirely freehand. The top of the full colour print that runs away slightly at the top can also be cut perfectly using the Cutting and Contour Tape.

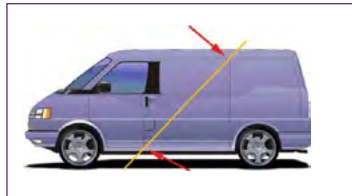

Defining working lines:

Defining simple working lines before starting the application of any lettering will enable the correct layout of text and logos. Tip: use fixed reference points, such as the corners and edges of doors and panels. This will simplify the layout of the opposite side of a vehicle as well as making any future repairs much more straightforward.



PPF bulk installation with cutting tape

Use this tape to place the correct cutting lines. Then install the PPF as you normally would. Now cut through the ppf , and on top of the cutting tape. Pull the cutting tape from under the ppf while spraying water under the . Result: nice cut and the paint is not touched.



QUICK TIPS A working line is an invisible contour reference line running horizontally over the length of the vehicle. Some cars already have a working line added during the forming of the bodywork. However, this is becoming less common in the more recent car models.

Price per roll



Do you need to layout text and large prints before final application? This industrial class tape is a hefty 5 cm (2") wide, has strong adhesion, but leaves no adhesive residue, even after several weeks. Not affected by water.

An ever-increasing number of bodywork components are being manufactured from composite materials. This is why you need Application and Positioning Tape.



QUICK TIPS Size: 50 mm x 50 m

This may also be of interest:



150-MM882

150-MM883

Price per roll



- Install over rivets, in channels and on bricks in no time!

The well-known RollePro is the only tool that really works for installing around rivets and applying wall s to brick or stone walls. The RollePro has a hard foam wheel that presses the into and around curved or uneven surfaces. Install the over the surface, warm it up and roll the RollePro over the shape or surface. Keep pressing firmly until the has cooled off, then heatfix and you're done.



Warm up the and roll RollePro simply over rivets channels, grooves or joints.



In this image you can see that the hard foam wheel easily takes the shape of the curved surface.



Even coarse bricks are no problem. The RollePro easily pushes the into irregularities of stones, bricks and joints.

Price per unit

SOTT® Roller - Heavy Duty SOTT



- 150 mm (6") wide
- Top-heavy version; with bearings

Professional roller mounted in ball bearings and intended for intensive use. Top heavy means that the actual rubber roller is the heaviest part of the tool allowing extra pressure to be exerted during application procedures. This is especially evident during the application of large areas of . Less pressure needs to be applied as the roller does most of the work.

IDEAL FOR:

- APPLYING LARGE AREAS OF WITHOUT AIR CHANNEL TECHNOLOGY BUT SOLID ADHESIVE
- APPLYING APPLICATION TAPE
- APPLYING LAMINATE
- APPLYING HIGH TACK S ON FLAT SUBSTRATES



The rubber roller is bearing mounted and so runs exceptionally true, offering highly efficient and effective rolling.



A good example of the use of the SOTT ROLLER: Covering large surfaces (such as a table) on your own with for example an interior with a very strong adhesive can be a challenge. With a roller, it is very easy and hassle-free. The roller gradually presses the onto the surface without tension or stretch, while a squeegee pushes the away slightly. On large surfaces, this can then cause a little tension. Not with the SOTT ROLLER!

Price per unit

Installation Roller *NEW*



- Aluminium frame
- Medium soft rubber wheel

Special pressing roller for installation of s in channels and trenches in vehicle bodywork. The advantage of a roller over a squeegee or rubbing with a glove, is that the (heated) does not poach. A roller pushes the everywhere evenly into the trench without moving it.

Tiles is not an easy surface to cover, especially when you must conform the inside the joins. Here is a tool that will help you out during this installation

INSTALLATION ROLLER
for channels and trenches in vehicles



Price per unit



*it's bigger
it's stronger*

it's **THE GOLIATH!**



All installers and signmakers use them.
The mounting magnet. With larger pieces of vinyl, however, one magnet just isn't enough. We have something better for that task. An extra-strong magnet, with a special handle. It's a monster! We call it The Goliath!

SOTT® Goliath Magnet - Extra Large SOTT

150-MM883

*super
strong
and no
mistake*



Mounting Magnets are now indispensable when installing vinyl and other s.

But we missed a satisfying solution for holding up large sheets of with just one tool - frustrating!

That is why we designed this special mounting magnet assembly and while we were at it made it multifunctional as well.

Specially designed for the true installer who appreciates efficiency and convenience while he works.



STANDARD MOUNTING MAGNET

THE GOLIATH

MORE THAN 24 KG OF PULL!
REPLACES 4 ORDINARY MAGNETS
MULTIFUNCTIONAL!

the 5 advantages of the goliath



EXTRA STRONG: MORE THAN 24 kg OF PULL!

There are 2 different attachments available that add a completely new function to The Goliath. In an instant create a third hand when working with the hot air gun or create a special rack for your squeegees and fluids*. Nothing is more annoying than magnets and fall down whilst positioning. The standard magnets often turn out to have too low a magnetic force, which means you end up using several magnets to do the job. Thanks to The Goliath this is a thing of the past. The base contains 6 Neodymium magnets that together develop a minimum of 24 kg pulling force. The Goliath is so strong that one of them can hold up a 1,52 m x 5 m of . So just clamp it down with The Goliath and start installing!



LIGHT GREY BASE FOR BETTER DIRT CONTROL

Avoid stains caused by your tool. The Goliath has a light grey rubber base that shows dirt well. By cleaning it regularly you can be sure that the magnet won't leave any dirt traces.



ROUNDED HANDLE: PREVENTS DAMAGE TO THE

Often during installing the upper part of the drops over the magnets, causing ugly kinks or folds in the . The Goliath however, has a rounded top to prevent this.



10 mm (0.4") HOLE FOR ADDITIONAL ACCESSORIES

Toward the top of the handle there is a 0.4»(10 mm) hole. This creates interesting possibilities for The Goliath. Available accessories are simply stuck into the hole, creating a whole new functionality for it.

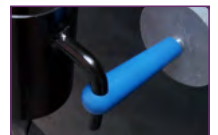

QUICK TIPS

Perfectly combine with:

150-MM885

Price per unit

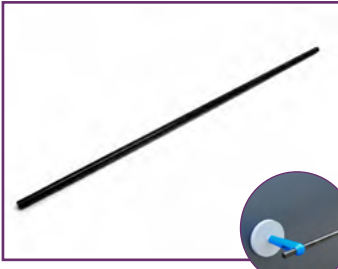

- YOUR 3RD HAND DURING INSTALLATION

Materials and tools often clutter up the space around the vehicle during installation. What could be nicer than a handy bracket to hang your cloths and spray bottles? Installers often find they just haven't got enough hands for everything. A third hand would be so welcome. We have the solution for both problems.

CLEAN AND ORGANIZED WORK

Workshops usually look like this: rags and degreaser spray bottles everywhere and installers running around cars looking for them. Simply use the SOTT dispenser to keep all the articles off the floor, so that everything stays clean - plus you have everything within reach.

**Note: these accessories require 2 Goliaths.*

YOUR 3RD HAND WHILST PRE-STRETCHING

The newest method to wrap small round shapes such as a door handles, antenna bases or mirrors, is to pre-stretch the to stretch and then, during the installation, to heat-shrink it again. The SOTT Dispenser is your perfect assistant! Attach the to the bar and you can heat and stretch it as much you like.

*Product information:
The SOTT Heat Gun Holder is made of durable black passivated metal so it's corrosion-protected.*



QUICK TIPS

Note, The SOTT Heat gun Holder only works with two magnets type:



150-MM883

The SOTT Dispenser simply fits into the holes in the handles of The Goliath mounting magnets.



With a length of 60cm it is the ideal bar to pre-stretch the vinyl before you start wrapping, say, a mirror.



Hang your cloths, spray bottles, etc. on the SOTT Dispenser and your tools will stay clean and be at your fingertips.



Price per unit



Forget all the standard magnet



introducing the SOTT Magnet

SOTT® Mounting Magnet SOTT

150-MM882



Just about every signmaker, carwraper and installer uses them. Mounting magnets. This handy tool keeps the sheet of on the car body during positioning and installation. There are many types and shapes available, always with some kind of problem: too sharp, handle too small, the rubber rubs off or simply not powerful enough. Here is the SOLUTION:

A mounting magnet designed by people who really gave it some thought and that combines many advantages into one. Forget about the rest. From now you'll only want to use the SOTT mounting magnet.



THE MUSCLE MAN: MORE THAN 7.5 KG OF PULL!

A common complaint of installers is that mounting magnets often lack just that little extra in force. The SOTT mounting magnet solves that issue. The base contains 6 Neodymium magnets that combine into a magnetic force of over 7.5 kg. As a result, fewer magnets are needed in one place to keep the sheet in place, which won't fall readily off the car.



LIGHT GREY BASE FOR BETTER DIRT CONTROL

Avoid causing stains with your tool. The Magnetor has a light grey rubber base that clearly shows dirt settling on it. By cleaning it regularly you can be sure that the magnet won't leave any traces of dirt.



ROUNDED HANDLE: PREVENTS DAMAGE TO THE

Often during installing the upper part of the sheet drops over the handles of the magnets, causing ugly kinks or folds in the at the spots where it touches the handle. SOTT mounting magnets, however, has a rounded top to prevent this from happening.



QUICK TIPS

Order quantity per piece

Price per unit



- 4 Storage compartments
- Belt included

This mini tool bag has a width of 13 cm and is ideal for installers who only need few a different tools for their installations. The tool bag has 3 compartments on the front and a hidden compartment on the back. On the front there is also a loop to attach a tape measurer.

QUICK TIPS Belt included 

Price per unit



- The most versatile toolbag available
- Belt not included

Professional installers often find themselves doing acrobatic feats to get to their tools whilst working. SOTT wants to respond to the needs of installers. So SOTT designed a special ToolBag which fully meets the requirements of professional installers across Europe.



MAGNETIC COMPARTMENTS



There are magnetic plates sewn into the material to conveniently stick your installing magnets.

BLADE STORAGE COMPARTMENT



No more old dull blades lying around! Put them into the special section in the 120-OLFA AB10 or 120-DB blade box. This box is specially made for this purpose.

SPECIALY DESIGNED KNIFE COMPARTMENTS



8 knife compartments with custom depths of 8 and 10 cm to make sure your knives always peek out a little. This way you can grab and return them quickly.

SAFE TAPE MEASURE HOLDER



The tape measure holder is made of sturdy plastic to avoid inadvertent damage when you lean against a car.

MOUNTING TAPE HOLDER



On the bottom of the TOOLBAG there is a belt with a quick release. Attach your mounting tape there to quickly grab it when you need it.

PROTECTED AGAINST DAMAGE



SOTT's TOOLBAG is especially made of industrialgrade textile material and has an elliptical shape to reduce the change of scratching the vehicle.

STURDY PLASTIC STRAP



SOTT chose to use a sturdy, industrial-grade strap that doesn't bend or collapse when your TOOLBAG is filled with tools.

QUICK ACCESS SQUEEGEE POCKETS



The TOOLBAG has 2 extra pockets with adjustable depths for squeegees that you want to grab without looking.

EXTRA MAGNETIC POCKET





On the front there is another magnetic pocket underneath the material to stick metal tools or screws. Ideal and very clever!

SPECIAL SHAPE



SOTT's TOOLBAG has one large compartment in the middle for gloves, wipes, etc. It has a special shape, so it doesn't bother you by wiggling between you and the vehicle. This reduces damage-prone situations.

QUICK TIPS Use with:  

400-017S

400-022

Price per unit



GET MORE FROM YOUR SOTT TOOLBAG

special tool bar provides

The famous SOTT Toolbag already has many qualities. The many pockets and compartments and the well-thought-out layout make this tool bag very popular throughout the World. But we've added some qualities.

additional benefits



Haven't used the SOTT Toolbag yet? Now there are no excuses any more.

LONG ANTICIPATED

Toolbag owners may have wondered what those two elongated loops on the front are for. Well, now the cat's out of the (tool)bag: they are designed for holding a metal bar that slides into them, so your Toolbag becomes even more universal and can carry even more tools. This SOTT Toolbag bar is made of black passivated metal and is sized to allow for various tools to be hanging on it.

EASY FOR SPRAY BOTTLES



IDEAL FOR LARGE TOOLS



SQUEEGEES WITH GRIPS



BIG ENOUGH FOR BOTH



SOTT® Toolbag Bar SOTT

400-022



- Especially for large tools

To make the SOTT Toolbag (400-016S) even more complete, there is a special bar available that can carry large plastic squeegees, window squeegees, spray bottles, etc. Slide the bar into the two existing loops and done. The SOTT Toolbag bar is made of black passivated metal and thus resistant against rust and oxidation.

Price per unit

SOTT® Heavy Duty Belt SOTT

400-017S



Belt suitable for the SOTT Toolbag (400-016S)

Price per unit



- Everything you need, carried in 1 toolbox

A standard toolbox can't contain all the tools you need during a carwrap job. As always, you just don't have not enough compartments for your special knives and squeegees, bottles will topple over and so on. But not anymore! Now you can have the SOTT Toolbox.

*Bigger = Better
Up to
more space!* **200 %**

LARGER FORMAT: VOLUME 30 liter



With a slightly bigger footprint of 52 cm x 30 cm the SOTT TOOLBOX has a capacity of 30 liters. So you will have everything you need right by your side.

2 BOTTLE HOLDERS

The SOTT TOOLBOX comes with two additional bottle holders that can be attached to the TOOLBOX with Velcro. Now you can take up to 4 (Spray-) Bottles along without them toppling over.

RULER HOLDERS

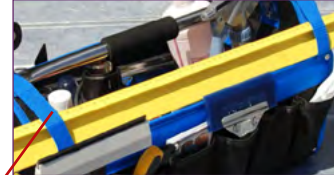

As many as 4 sturdy straps with Velcro hold your longer tools, such as cutting rulers.

22 ATTACH STRAPS



Along the inside of the TOOLBOX are 22 tool straps for you to store your tools. They are designed for quick access, just as everything about this tool box is!

QUICK ACCESS POCKETS



Knives and pens are easily accessible for use on the front of the box and there is space for your mobile phone as well.

18 COMPARTMENTS



As many as 18 compartments on both sides for your squeegees, blade holders and many other tools and materials.

6 PLASTIC FEET



The box stands on 6 large plastic feet that avoid damage and soiling of the TOOLBOX when it sits on the floor and keeps it dry.

STAINLESS BRACE WITH HANDLE



Comfortable to carry thanks to the strong stainless brace with handle.

TAPE MEASURE HOLDER

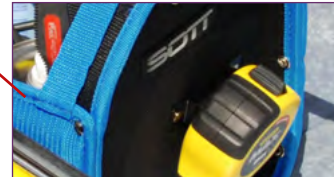

On the back there is a strong metal clip for your tape measure. Everything is designed for quick access.

SHOULDER STRAP



Standard supplied with shoulder strap that can be attached to the special braces on the box.

Price per unit



Squeegee I

400-010



- Easily apply in the most awkward of places

A handy tool for every professional fitter. For both car wrapping and window applications. Using this thin smooth plastic spatula, can be worked in to the smallest corner and the narrowest of gaps without fear of damaging the . can now easily be applied to the bumper seams, rear lights or roof rubbers.



The special slender shape enables the application of in to all manner of seams and joints.

Price per unit

Squeegee II

400-009



- Guide between window and door seals, push in to joints

looks at its best when applied under the seals avoiding unsightly gaps. This handy tool is ideal for lifting the seals so that the can easily be applied underneath. The Squeegee-2 is made of smooth plastic and is thin enough to avoid the seals being opened too much or getting damaged. This tool makes the application of under door trims, window and roof seals a breeze.



The slender form of this tool enables seals to be lifted effortlessly.

Price per unit

Nylon Pushstick

400-001

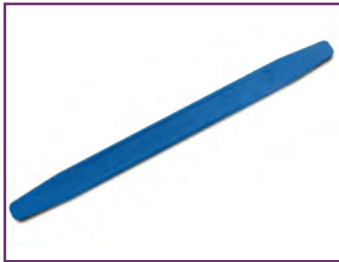

Sturdy plastic spatula for pushing back or easing of rubbers around headlights and roof trims when applying . Can also be used for positioning in hard to access areas.

Price per unit

Doorgasket Puller

400-002



Easy tool for tinting of cars, to get the door rubbers in their proper place again, when they were pushed down while tinting the window.

Price per unit

The Factotum II

150-095



- The solution for small corners, holes, seams and cracks - Unbreakable material

Every mechanic knows it: mounting self-adhesive in places that are hard to reach. The Factotum-II is a handy mini oval with two usable sides. It guides every in the smallest corner or kink, without destroying the while pressing. The smooth rounded corners give you the perfect opportunity to guide the to where you want it.

Medium stiff and unbreakable.



Price per unit

Opaquer - Fine Tip

400-012



- **Damaged ? Just repair it!**
- **Waterproof, black opaque, sticks perfectly on pvc, plastics, glass, etc.**

For use with window : Opaque black ink is great for repairing window . Just touch up the 'open' area and from the outside the damaged area has disappeared.

For use with dark printed : apply black to the edge of the ; this looks much better than the normal white edge.

Price per unit

Opaquer - Wide Tip

400-013



Same as 400-012 but with a broader tip.

Price per unit

China Marker - for s

400-008



White wax pencil, for marking on s, glass, carpaints, etc. Easily wipe your mark away with water and a cloth or SOTT Surface Cleaner-II (600-SC02).

MARKS EASELY ON:

- **PVC S, PPF S. POLYESTER S, WINDOW S, INTERIOR S**
- **GLASS, STEEL, WOOD**
- **COATED SURFACES**

Price per unit

SOTT Seal - It Pen SOTT

400-007



Here's a fast, simple answer to your edge sealing problems that require edge protection. The SOTT SEAL-IT PEN contains brand 4005 UV blocker acrylic clear, for a fast drying (15 minutes), long lasting edge seal. SOTT's SEAL-IT PEN is compatible with all type of s, simply follow the instructions that are included with each SEAL-IT PEN for your specific application.

Price per unit

Edge Sealing Tape - Black

400-011



- **Roll size: 25 m x 15 mm**
- **For sealing the edges of window s and other s**

EDGE SEALING TAPE is a good alternative when sealing the edges of window s with silicone sealant is not possible or desirable. This tape prevents corrosion, deterioration or loosening due to moisture or dirt getting under the . Also good to use for sealing edges of print s, car wrap s, etc.

VERY LONG LIFE FOR OUTDOOR USE

CAST PVC

CAN BE INSTALLED DRY

NO DISCOLORATION

HIGH PERMANENT ADHESION

Price per unit

Edge Sealing Tape - Clear

400-011C



- **Roll size: 25 m x 15 mm**
- **For sealing the edges pvc s, interior s and wrap s**

EDGE SEALING TAPE Clear is specially designed for sealing and protecting the edges of s. The tape is virtually invisible and is applied dry over the edge of the and the substrate. This seals the edge of the and prevents it from coming loose and curling up. Also, no dirt or moisture can creep under the .

VERY LONG LIFE FOR OUTDOOR USE

CAST PVC

CAN BE INSTALLED DRY

NO YELLOWING

HIGH PERMANENT ADHESION

Price per unit



STANLEY® Max Tape Rule - Professional **STANLEY**

No more mistakes due to inaccurate measurements.
 Never again will your tape rule retract – catching your fingers in the process...
 No more delays because of collapsing or bending tape rules.

*Discover the advantages of proper,
 high-quality measuring tools!*

A valuable addition to your tool kit and a sheer relief: finally you will be able to easily measure height without the blade bending due to wind or standout. You will be able to measure the length of an advertising board, neon sign or trailer, knowing the blade will stay straight and won't fall off the edge. These STANLEY tape rules are exceptionally sturdy, finally meeting the every-day needs of window installers and signmakers.

STANLEY® Leverlock Tape Ruler - 3 m **STANLEY**

350-RM3



This professional-standard STANLEY tape rule is perfect for any type of work, thanks to its handy size and the fact that the blade, once extended, is automatically locked.

- Shockproof case
- Blade does not automatically recoil when extended
- Simply press the button and the blade retracts
- Polymer coated tape
- Bi-material case made of soft elastomer
- Tru-Zero hook allows for exact inside and outside measurements
- Belt clip
- Accuracy: class II

Price per unit



- RUBBER GRIP
- MYLAR PROTECTIVE COATING
- BI-MATERIAL CASE
- BELT CLIP
- LOCK BUTTON
- ACCURACY: CLASS II
- DOUBLE TOP HOOK
- HOOK GRABS ON SIDE, TOP OR BOTTOM
- A SPECIAL BUTTON ALLOWS YOU TO SLOW DOWN RECOIL
- BLADE ALLOWS FOR STANDOUT UP TO 270 CM WITHOUT COLLAPSING

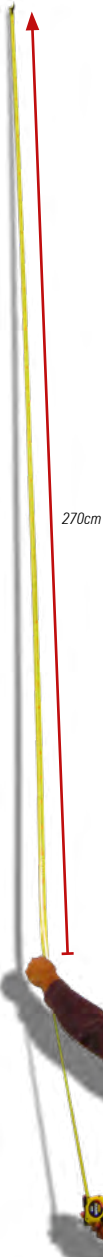

270cm



Airlock™ system

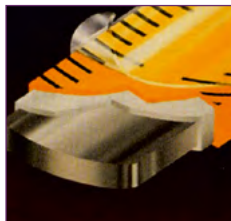

Mylar™ Coated



2 Side Grip



Extra Strong

KINZO® Tape Ruler - 2 m and 5 m length

- Magnetic
- Centimeters and inches

Plastic tape measure and rubber ribbed housing for added grip. The built-in magnet to attach to metal surfaces. The tape measure indicates both centimetres and inches. Available in 2 m and 5 m lengths.

2 m version

350-KRM2



Price per unit

5 m version

350-KRM5



Price per unit

Workseat - with Gas Lift

400-019



- An end to backache!
- For easy movement around the car while applying your signs.
- No more tools lying around!

This is extremely convenient: a gas-lift work stool with a tool tray and castor wheels. The soft, comfortable upholstery keeps you comfortably seated even during lengthy jobs. Underneath the seat, a ring has been fitted with which you can operate the gas lift, adjusting the height to your exact preference.

The tool tray consists of three compartments for the tools you're working with, separated by a ridge.

The castor wheels include bearings and are made of hard plastic, with full rubber, durable and easy-rolling tyres. Very good adhesion to all types of substrates except granite. With one tube you can seal about 35 linear meters.

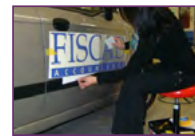

Price per unit



QUICK TIPS

Maximal weight is 120kg

Window Tinting Light

NEW

350-LL01



- 28 COB LED light with more than 3000 Lumen in full power mode
- 2200 Mah battery
- +3H of service + battery indicator level only 3H for full charge
- Self magnetic
- Key ring function

THE ULTIMATE light for window tinting! Strong COB light which will help you during the cutting process, whatever tint you have, and thanks to its 3 function modes and foldable stand, you will always get the right angle. Moreover, it has an internal battery with + 3 hours of service, perfectly useful when we all know the stress of finding an outlet for a regular working light station. easy-rolling tyres. Very good adhesion to all types of surfaces except granite. With one tube you can seal about 35 linear meters.



See by yourself the high brightness level!
+80% tinted window here.

Price per unit



Sealant DOWSIL 995 - High Impact

600-995



- **Extremely strong and resilient**
- **Also works as a bonding between and glass/frame**
- **305 ml**
- **Colour: Black**

This odourless industrial sealant with high tensile strength is ideal for structural bonding between (safety) window s and glass. The sealant also seals particularly well against corrosion, leaks etc.

Great for bonding window s to the edges of the glass/frame in situations where break-ins, falls through or explosions are a possibility. With one tube, you can seal about 35 linear meters.

- *Non-corrosive curing system. Fully dry and at strength after 20 days.*
- *Hardens into an extremely tough elastomeric rubber that ensures a durable, flexible, watertight bond.*
- *Excellent weather resistance and high resistance to ultraviolet radiations, heat and humidity, ozone and extreme temperatures.*
- *Excellent adhesion without primer to numerous surfaces including coated, tempered, and reflective glass and anodized, plastic or painted aluminum profiles including most fluoropolymer-based paints such as Kynar.*

Price per unit

Sealant SILIRUB2 - Normal

600-752



- **Silicone sealant**
- **300 ml**
- **Colour: transparent**

High quality sealant for sealing window s' edges to prevent corrosion. UV resistant, long-lasting. Very good adhesion to all types of surfaces except granite. With one tube, you can seal about 35 linear meters.

Price per unit

Sealant SILIRUB2 - Silicone Sealant

600-753



- **Silicone sealant**
- **300 ml**
- **Colour: Black**

High quality sealant for sealing window s' edges to prevent corrosion. UV resistant, long-lasting. Very good adhesion to all types of surfaces except granite. With one tube, you can seal about 35 linear meters.

Price per unit

3M® Edge Sealer 3950 3M

600-3950



- **For sealing the edges of PVC s**
- **0.23 L Container**

3M Edge Sealer 3950 is a clear varnish that provides a water and dirt tight seal between the edge of self-adhesive PVC s and the surface. It can also prevent edge curling.

Edge Sealer is resistant to water, mild acids and salts. Not resistant to hydraulic oils and greases. Edge Sealer can be removed with isopropanol alcohol and citrus-based cleaners.

How to use:

- *Before you begin, test it out to make sure that the Edge Sealer does not affect the surface.*
- *The surface and the must both be degreased and clean.*
- *Make sure that the 's edge is well pressed in accordance with the manufacturer's guidelines.*
- *Do not dilute.*
- *Do not leave the lid off the jar for too long; this will reduce how long the contents can last*
- *Apply the sealer with a 6mm thin brush in one smooth movement.*
- *Make a 6-10mm seal edge, covering both the and the surface.*
- *Avoid gaps between the different seal edges.*
- *Allow the seal edge to dry for 24 hours.*

Price per unit

HEAT GUNS & MORE

Use thermal tools to control the heat and shaping of your materials. Thanks to their thermal performance, our tools allow you to control the heat and thus obtain a precise and uniform result. In addition, their ergonomic design and ease of handling make them comfortable and safe to use for long periods of time.



HEATMASTER2 Heat Gun - 2000 W**400-HM-2**

- Perfect for sign makers
- Ideal for window tinters
- Indispensable for car wrappers

Indispensable for installers, essential for sign makers: a hot air gun to heat the to stretch or shrink it into the desired shape. Every professional installer has one.

- 2 TEMPERATURE SETTINGS
- 450 - 600 °C
- 3 M CABLE

Price per unit

STEINEL® Heat Gun Standard - 1600 W**400-HL1620S**

- Perfect for sign makers
- Ideal for window tinters
- Indispensable for car wrappers

Indispensable for installers, essential for sign makers: a hot air gun to heat the to stretch or shrink it into the desired shape. Every professional installer has one.

- 2 TEMPERATURE SETTINGS
- 300 - 500 °C
- 2.2 M CABLE

Price per unit

STEINEL® Heat Gun Digital 2200 W - Soft**400-HL2020E**

- Perfect for sign makers and installers

Electronic adjustable temp. settings with memory. Infrared scanner is optionally placeable on top.

- 3 AIR FLOW SETTINGS
- 80 - 630 °C
- 2.2 M CABLE

Price per unit

STEINEL® Heat Gun Expert - 2200 W + Extra Long Cable**400-HG2120E**

- Perfect for sign makers and installers

What a misery! On conventional hot air guns the power cord is too short, so many a times the plug gets pulled from the outlet when you are using it. This Heat Gun eliminates that problem. It has a 7.5 meter long industrial neoprene power cable.

Advantages: always flexible, better heat resistance and no more need for an extension cord.

- 3 AIR FLOW SETTINGS
- INFINITELY ADJUSTABLE TEMPERATURE SETTINGS FROM 80 - 630 °C
- 7.5 M CABLE

Price per unit

STEINEL® Heat Gun Expert - Battery**NEW****400-HG2120EB**

How many times does the heat gun cable get stuck around the tires of a car or maybe a scaffold?

Here's the heat gun with a battery that allows you to work nimbly without worrying about unplugging and replugging cables from electrical outlets.

- NO CABLE - HIGH-POWER - DIGITAL DISPLAY SETTING
- 50 - 500 °C

Price per unit

STEINEL® Battery for Heat Gun Expert**NEW****400-HGBAT**

Battery for heat-gun 400-HG2120EB

Price per unit



STEINEL® Heat Gun EXPERT - CS - 2200 W + Extra Long Cable STEINEL

400-2120E-CS



What a misery! On conventional hot air guns the power cord is too short, so many a times the plug gets pulled from the outlet when you are using it. This Heat Gun eliminates that problem. It has a 7.5 meter long industrial neoprene power cable. Advantages: always flexible, better heat resistance and no more need for an extension cord.

- 3 AIR FLOW SETTINGS
- INFINITELY ADJUSTABLE TEMPERATURE SETTINGS FROM 80 - 630 ° C
- 7.5 M CABLE



QUICK TIPS

Infrared Temperature scanner included



400-HLSCAN

Price per unit

STEINEL® Infrared Temperature Scanner STEINEL

400-HLSCAN



- Insurance cover for temperature
- Sensitive workpieces.

Temperature scanner HL Scan monitors workpiece temperature by a beam of LED light. An acoustic and visual signal warns the user when temperature exceeds or falls below the permissible limit. For the 400-HL 2020E and 400-HG 2120E.



Price per unit

HL Light for STEINEL® Heatgun STEINEL

400-HLLIGHT



- Attachable light for illuminating the workpiece.
- For working more easily in dark environments.

Delivering over 100 lumens, the powerful LED light makes work easier in dark environments.



QUICK TIPS

Can be attached to HG 2320 E, HG 2120 E, HL 2020 E, HL 1920 E and HL 1820 S hot air tools.

Price per unit

STEINEL® Guard Cage STEINEL

400-HLGUARD



- Protect yourself and the material
- Specially for Steinel hot air tools

This heat-resistant guard cage is easily slid onto the hot air tool and helps prevent burns to both the user, as well as material burns. An ideal tool for car wrappers, window tinters and interior fitters.

The protective cage is made of heat-resistant plastic and is assembled in no time. It can also be used in conjunction with the HL Scan temperature scanner.



Price per unit



QUICK TIPS

Can be attached to HG 2320 E, HG 2120 E, HL 2020 E, HL 1920 E and HL 1820 S hot air tools.



Post-heating on the right temperature?

TESTING is knowing!

Heat-setting the after working it into channels and recesses is a necessity. Whether this is done with a hot air gun or torch, one question remains: how do you know if the has acquired the right temperature?



The SOTT Infrared Meter measures it for you. Fast and simple. You simply aim the laser at the object you are heating up, and the gauge will immediately indicate the current temperature. Added to that you can keep the last temperature reading by releasing the front button. An ideal and indispensable tool for any signmaker, car wrapper or interior installer who needs to know whether the right temperature of the has been reached. Includes a 9 volt battery.

3 ADDITIONAL FUNCTION BUTTONS

Light button for display illumination.

Set to Celsius or Fahrenheit.

The laser pointer must be turned on and off manually.

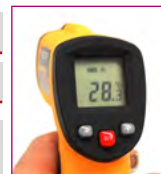

TECHNICAL INFORMATION:

Mesuring range: -50°C/450°C (-58°F/842°F)	Emissivity 0.95 (fixed)
Accuracy: ±1.5 °C / ±1.5%	C°/F° Unit selectable Laser ON/OFF selectable
Resolution: 0.1°C or 0.1°F	Auto power Off & Data Hold
Distance spot radio: 12:1	Backlight ON/OFF selectable Use one standard 9V battery (6F22)



QUICK TIPS

INCLUDED:
9 Volt battery

Price per unit

Gas Torch - with 13 mm Fine Burner **SIEVERT**



- Reshaping or heat-setting is faster and has better results
- Heat-set the in those awkward places without heating the adhesive layer and substrate

High quality gas burner - Sievert - Made in Sweden. Especially intended for working and heat-setting in channels*. This burner produces tremendous heat allowing the correct temperature to be achieved in a fraction of the time when compared with using a heat gun and a temperature gauge.

The main disadvantage with a heat gun (paint remover) is that it also heats both the bodywork and the adhesive layer. This is highly undesirable as this is also the removal temperature.

In short, a burner is the best solution for heat-setting to all of those awkward areas.



Flame temperature: 1.925°C!!!

The tip of the blue flame reaches 1.925°C (3,500°F) and releases heat instantly. This is in direct contrast with a heat gun that supplies heat via an air stream.

The burner is moved quickly over the surface, so it only heats the upper layer. The lower layer and the adhesive layer remain unaffected by the heat and so do not melt. The itself is heated to a casting temperature (more than 205 °C) in a fraction of a second, but cools instantly when the burner is removed.

Burner Starter's Kit

400-BB-2235

- **SMALL FLAME: 13 MM**
- **EXTREMELY SAFE IN USE**
- **CLICK-ON-CLICK-OFF**
- **HIGHLY ECONOMICAL; 80 CARS PER CARTRIDGE**
- **ELECTRONIC IGNITION NO ELECTRICAL POWER REQUIRED**
- **LIGHTWEIGHT SYSTEM**



Supplied in a box with a 600 mm cartridge.

Price per unit

Powergas 600 ml

400-BB-2204



Economy: at least 80 cars.

Price per unit

Powergas 300 ml

400-BB-2203



Economy: at least 40 cars.

Price per unit

Infrared Nozzle - No Air Displacement

400-BB-8708



- Does not blow hot air
- 1700 w of direct radiant heat

Special attachment for the SIEVERT Cyclone gas burner. This attachment is special because it gives instant radiant heat from the flame inside it, without any blowing or air displacement. This lack of blowing ensures that your does not get blown against bodywork as is often the case with hot air guns, or that surrounding areas of are subjected to unnecessary heat. This infrared attachment provides instant radiant heat without taffecting the flow of surrounding air. Manufactured from durable metal.



Solid construction in durable metal.

The flame from the burner is safely encased in the attachment so it cannot cause fires.

Price per unit



Simply Heat Up Corners and Fixate them together

The CORNERSEALER



Are there tools that can simplify installation? Yes, definitely! SOTT introduces a selection of handy tools that no installer should go without.

Have you ever had small creases pop up at the corners of a wrap? Or small overlaps that lose their adhesion? This practical tool is intended for releasing the tension off installed edges around corners.

The CornerSealer allows you to melt small creases or curly edges and close or flatten them.



Within seconds, the flat head gets hot enough to melt the .

Simply push the hot flat head against the crease or overlap and 'melt' the (s) together and/or in place.

This effectively fixes the edge of the until it is tension-free in its new shape. The flat head allows you to melt small creases or curly edges and close or flatten them.

PERFECT FOR:

- FIXATING THE EDGES OF WRAPPED AROUND CORNERS
- MELTING TOGETHER SMALL OVERLAPS

HOW TO USE:

1. Make sure is clean and degreased
2. Activate the device to preheat the flat head. This takes about 10-15 seconds (preheating time increases with deteriorating batteries).
ATTENTION! Head can get hot!
3. Avoid skin contact to prevent injury
4. Place the flat head against the area and push down firmly
5. Avoid overheating! 1-3 seconds of pressing is usually sufficient



QUICK TIPS

ABS housing Pocket-size Works on 2 alkaline batteries (not included)

Price per unit

WORKSHOP GEAR

Our products help you optimise your workspace safely. With our range of workshop equipment, you will benefit from a comfortable, fast and safe installation, for an optimal result.



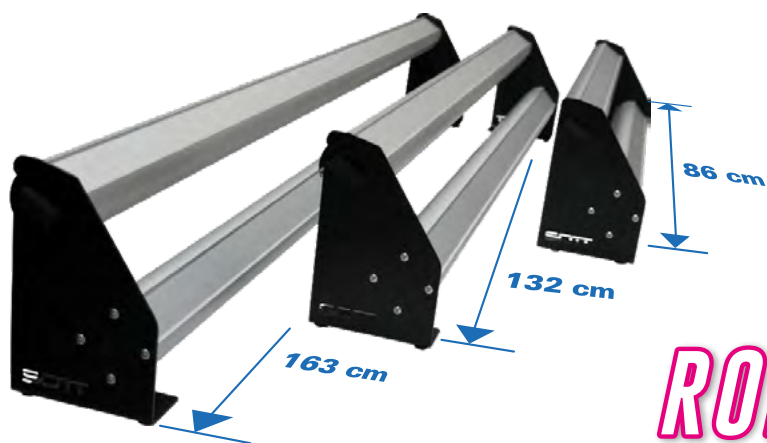

professional ROLL SUPPORT

Amazingly practical tool for unrolling application tape, car wrap or window s on your cutting table.

Heavy duty anodized aluminium dispenser with black coated steel side plates. Perfect for application tape or unwinding rolls of window and vinyl. Specially made for rolls of vinyl with a 3-core.



500-SRS86
500-SRS132
500-SRS162

86 cm
132 cm
162 cm

Price per unit
Price per unit
Price per unit

RFX Applicator for Application Tapes

500-017



Troubled by air bubbles or wrinkles when applying application tape to your ? Just use the RFX applicator. This handy little tool is 30cm wide and totally removes any creases or air bubbles between your application tape and .

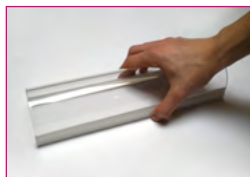

Price per unit





professional ROLL SUPPORT



Simply and quickly slide the roll guide into the special position slots.



Perfectly finished endcaps smoothly slide into the position slots. This stabilizes the dispenser even more.



The dispenser comes complete with mounting brackets, screws and an Allen key. Just put it together and it's ready for use.



Corner brackets that can be mounted as needed so the dispenser «clamps» onto the table are included.



The two aluminium roller guides enable you to unroll your vinyl or application tape either from the top or the bottom.



The stable dispenser construction enables the perfect unrolling of wide rolls, such as carwrap s, without any kinks or creases.



The roller guides are made from anodised aluminium with a metal profile along their entire length to prevent sagging



Rubber feet ensure it solidly sits on your table and they prevent damage. The dispenser can also be bolted to the table. A screw hole is provided for that purpose.



Has a perfect and safe finish thanks to its coated, solid metal build and rounded corners.



The HANDLER

*cut window perfectly straight
anywhere you like*



*Perfectly
STRAIGHT
and
ANGLED
CUTS*



Hang the handler on the wall or place it on a stand or stairs.

- Simple straight and angled cutting of window
- The ideal solution for on-site cutting
- Cut 2 or 3 pieces at the same time, perfectly straight!
- Rigid aluminum frame

Cutting window to size is not always easy. But with the handler, this is history. Simply place your roll of between the holders and pull the vertically down between the blade holders. Viola, you have a perfectly straight cut.

Now fold down the special clamping bracket against the and now cut your desired size horizontally against the guide. The clamping bracket ensures that the does not fall to the ground. Now you can pull any piece you cut out from under the bracket without the rest falling. is at a premium.

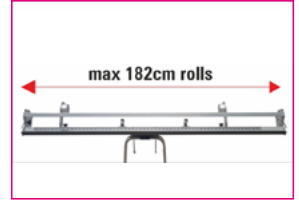

Lightweight, made of aluminium. Available in two sizes: for max 152 cm rolls and max 182 cm rolls.



The handler has 2 adjustable blades, so you can cut two or three jobs at once.



The roll holders are adjustable to any size.



Also, the roll holders have an adjustable braking system so the won't accidentally unroll.



Size indication is in inches and cm.



Cut your window vertically perfectly straight to your desired size.



Along the horizontal guide, cut the to size.



The handler for max 182 cm rolls

500-FH72

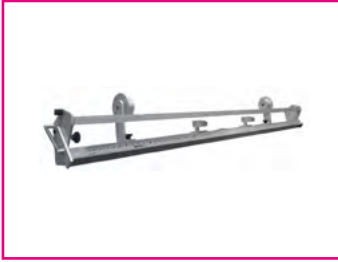

use with



120-FH

Price per unit

Spare Blades for Handler Dispenser

120-FH



- 20 pack

Spare blades for use in the cutting heads of the Handler. Supplied in a special dispenser.

Price per unit

Handler Extra Knige

500-FH-XKNI



- 20 pack

Spare blades for use in the cutting heads of the Handler. Supplied in a special dispenser.

Price per unit



Yup, it's here: **HOZELOCK**

Goes SOTT

THE FIRST UNIQUE SPRAY BOTTLE DEVELOPED BY SOTT AND HOZELOCK

- HEAVY-DUTY COMPONENTS
- BUILDS UP INCREDIBLE PRESSURE
- 1,25 LTR (42.3 OZ) CONTAINER
- UNBREAKABLE HARD SHELL CONTAINER



Easy to read icons, specially designed for the professional industry.



How-to-use instructions are printed on the container.



Indication in two measurement units.



Adjustable spray head for fine-tuning.



Heavy-duty pump handle.

**A must-have for every installer
in the Signage, PPF,
and Window industry.**



SOTT® Pressure Spraybottle - HOZELOCK - 1.25 L SOTT

550-4075



High quality pressure sprayer with 1250 ml contence, for the moisturizing of surfaces and . Not to be used for aggressive liquids or degreasers. In these cases use the SprayMaster (550-110).
For more info, read the ad-page.

Price per unit

SOTT® Pressure Sprayer - HOZELOCK - 7 L SOTT

550-4007



Large pressure sprayer (7 l) with a 5 litre liquid capacity. The large reservoir is easily pressurized, and the long hose and special trigger allow you to spray large surfaces prior to applying window . In other words: you can simply carry on with the job in hand without having to walk back and forth to the tap. The wrist cramp that often results from holding the trigger of ordinary sprayer bottles is a thing of the past as well.



The spray head (A) can be set for the amount of spray mist needed, and the pressure can be adjusted by A B turning a button (B) next to the handle.

Price per unit

Water Gun 1 L

550-WG



- Is not affected by chemicals, degreasers, cleaners, adhesive removers, acids or aggressive liquids!

You've never seen a sprayer like this! The Water Gun releases a powerful mist instead of just beads of moisture. With a range of up to 3 metres! The Water Gun has an enormous spread of spray and covers the entire surface with a 'cloud'. This mist is much finer than the beads of moisture normally associated with other sprayers. The turbulent spraying action not only ensures that the surface is more efficiently sprayed, but the resulting mist also 'pulls' any dust that happens to be swirling around out of the ambient air.

Do not hold the Water Gun upside down; the trigger may leak.

IMPORTANT: The Water Gun is not long-lasting resistant to screen-print ink cleaners and Right-Off adhesive remover (600-Z0415). After several weeks, the trigger may start to leak.



One of the biggest advantages of the Water Gun is the turbulent mist that it creates. This not only achieves a greater range of spray, but also removes dust particles from the atmosphere.



The remaining liquid content is displayed on the side of the bottle.

750 ml



The sprayer of the Water Gun is especially developed to supply a high yield of spray per pump action. The Spray Master is also resistant to aggressive substances.

Price per unit



THE ULTIMATE HIGH PRESSURE SPRAYER IS HERE

SOAK'EM ALL



- 12 UNIQUE FEATURES
- 8.3m REINFORCED HOSE
- MADE IN EUROPE



- A must-have for any installer who wants to work quickly and efficiently

The SOTT WATERBOMB is the ULTIMATE high-pressure sprayer and is for every window and PPF installer. No more messing around with small pressure sprayers that waste time needing to be re-inflated all the time.

The WATERBOMB can be pumped up to 6 bar with a hand pump or with a compressor giving you perfect pressure to spray the moisture on to your or surface for the whole of your working day.

The barometer indicates how much pressure you have left in your tank. The inner casing is made of coated steel which will not rust and is not sensitive to chemicals and acids. The SOAK'EM trigger is compact and easy to handle which makes it easy to use in small spaces. The special ultra-flexible hose is reinforced on the inside so that kinking, flattening or being run over is not a problem.

10 L
6 Bar



Storage compartment



Special storage compartment for small loose parts.

Extra large filling opening

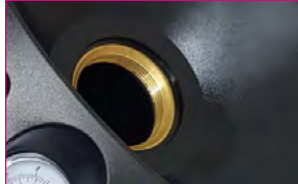

Quick filling is easy with the large filling opening.

Heavy duty pump



Very strong brass pump with heavy duty metal handle.

2 adjustable straps



The two adjustable straps give you the option of carrying the tank on your back.

Compressor connection



Awesome! Pump up in the morning and all day sufficient pressure!

SOAK 'EM nozzle



The SOAK'EM trigger made of durable plastic. The pressure can be regulated via the nozzle. The trigger is also lockable.

Integrated pressure gauge



Quickly and easily read the tank pressure on the built-in pressure gauge.

Rotatable connection



Unique: the connection between the nozzle and hose can be rotated without the hose rotating.

Blow-off/safety valve

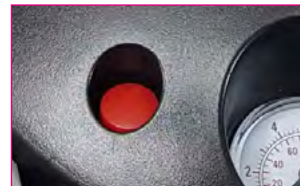

Just press the button and all pressure is off the tank.

Flexible heavy-duty hose



This flexible soft hose of no less than 8,3 m, is internally reinforced and can withstand a pressure of 15 bar.

Large foot + extra stability



The large foot stand ensures that the Water Bomb does not easily fall over during use.

Bottom connection



Because the hose connection is at the bottom, no residual liquid remains in the tank and again, it will not easily fall over.



QUICK TIPS

AVAILABLE SEPARATELY:



550-WSBS



550-WSE

Price per unit



Soak'em Trigger - for High Pressure Sprayers

550-WSE



Lightweight and handy trigger made of durable plastic. Intended for high-pressure sprayers such as The WaterBomb (550-WB10). The SOAK'EM trigger is only 21 cm long, making it very handy during use. Connection for hose: 1/4 thread inside.



The pressure and spray is easy to adjust the nozzle



The trigger can be locked for prolonged spraying.



The ribbed handle provides a good grip; even when completely wet.



QUICK TIPS

Fits perfectly on:



550-WSBS



550-WB10

Price per unit

Water Hose Reinforced - 8.3 m

550-WSBS



Flexible soft water hose with a length of 8.3 m. Specially designed for high-pressure sprayers such as The WaterBomb (550-WB10). This water hose with an internal thickness of 6 mm, has a reinforced inner core so it can have a pressure of 15 bar. This high quality hose is resistant to pinching, kinking, oils and mild acids and salts. Both connections of 1/4" outside.



Reinforced inner core for high pressure and resistant against oil, mild acids and salts

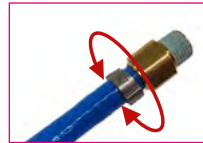

Swivel brass connector avoids twisted hose.



Ultra flexible and soft.



QUICK TIPS

Fits perfectly on:



550-WSE



550-WB10

Price per unit





- 10 L tank
- Manual inflation
- With pressure gauge
- 5 m spiral hose

The SteelMaster high-pressure sprayer is the little brother of the SOTT WaterBomb high-pressure sprayer (550-WB10). This high-pressure sprayer is easy to pump up to 6 bar with the handle. The built-in pressure meter shows how much pressure the tank contains. With the red button, you can vent the tank at once. The trigger has a screw-on brass nozzle.



Quick inflation with the handle



Large funnel-shaped filling opening



Plastic trigger



Plastic connections



Strong spiral hose



Pressure gauge



STEELMASTER put the pressure on



QUICK TIPS

SOTT WaterBomb components are non-interchangeable with this version.

Price per unit





- No more unsightly curled up pieces of tape

It's always been a problem: securing your rolls of material after use. Usually they are just taped up, but this often means that when the tape is removed, the material gets damaged. Not anymore!

Just use the Speed Clip.

This clip is made from a soft flexible plastic with a special finger recess allowing you to simply slide it along the roll without damaging the material. The clip then closes securely around the roll, holding the roll together.



Keep your ROLLS TIDY and in an ORDERLY fashion

Eliminates the chaos of unsightly taping

The Speed Clip ensures order and a clear view of your stock. It can be used on all types of material.

When the clip is removed, the material remains totally undamaged, but the Speed Clip does much more. Here are a few examples.



Handy finger grip



Flexible and self-closing



Rounded ends



Automatic spacing



Leaves no impression on the material



Suitable for window frames



Can be used on thick rolls



Ideal for laminates



Space for logo or company name



QUICK TIPS

After intensive use Speed Clips may develop some "play". No problem. Just place the Speed Clip in some hot water, and after a short time it will return to its original shape.

Price per unit

LIQUIDS

Our high-quality products include application fluids to facilitate installation, cleaning solutions to remove impurities and stripping solutions to facilitate the removal of existing adhesive. Use our fluids to keep your jobsite clean



Right-Off Adhesif remover Goes GREEN!

FOR MORE THAN 20 YEARS SOTT'S RIGHT-OFF HAS BEEN THE ULTIMATE ADHESIVE IN EUROPE. CAN WE TOP THAT? YES, WE CAN!

Which is why we are introducing Right-Off 2.0, a new version that removes adhesive, glue and grease even more efficiently than version 1. It's easier and faster than before. It even removes the newest types of adhesives used by vinyl manufactures. And - maybe most importantly - it is completely environmentfriendly!



Simply spray it on, let it do its magic and scrape the goo from the undamaged surface.

Right-Off 2.0 removes more types of adhesive than the old version. Even specially primecoated adhesive systems are no match for Right-Off 2.0

NEW POINTS OF SALE

- STRONGER CLEANING POWER!**
- FASTER AND BETTER!**
- JUSTE RINSE AWAY WITH WATER!**
- GREEN, ECO-FRIENDLY SOLVENT!**
- NO HAZARDOUS GOODS SYMBOLS!**
- SAFER IN ITS USE!**
- NO ADR CLASSIFICATION!**
- EASIER TO TRANSPORT!**



LIQUIDS REMOVAL



Right-Off - Adhesive Remover **SOTT**



- Removes adhesive residue in 2 minutes
- Also removes tar, grease, chewing gum, paint, etc.
- Harmless to all substrates

Right-Off will not only remove adhesive residue from self adhesive and window in less than 120 seconds, but also tar, grease, lubricants, chewing gum, etc. from carpets, upholstery and from plastic, Perspex, Beauty Board, rigid foam, metal, bisonyl, banners and painted surfaces. pH neutral, harmless to substrates and is not classed as a hazardous substance. Suitable for use on all types of .

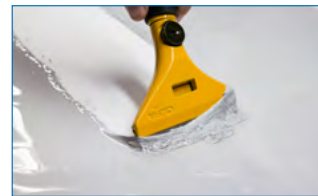

**SAFE and
LIGHTNING
FAST
adhesive
removal**

Instruction for use:

1. Apply Right-Off to the surface and wait for 60-90 seconds.
2. Using a Lil' Gripper scraper (300-006) scrape the resulting residue into one place.
3. Collect the residue using polishing paper (300-040). Repeat the procedure until all adhesive residue has been removed. Apply additional Right-Off as required
4. Thoroughly clean and degrease the treated surface with Surface Cleaner-II (600-SC02) before drying with a clean cloth.

1 L Bottle

600-Z0415FLES

5 L Jerrycan

600-Z0415CAN

200 L Drum

600-Z0415VAT



Price per unit

Remover **SOTT**

600-TRL1000



- Removes self-adhesive pvc s from automotive paints, wood, expanded-foam boards, decor panels, glass and metal.
- 5 L

600-TRL1000 is a thick, gel-like liquid that is applied with a brush to self-adhesive s that are to be removed. Wait a few minutes and the will begin to separate itself from the surface. Repeat if necessary. Works on cast, polymer and monomeric s.

Not suitable for multi-layered s such as retro-reflective s and laminated s. Do not use on soft fragile substrates such as plastic, rigid foam, banners, tarps, acrylics, acryl paint, etc.

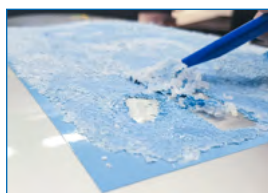

QUICK TIPS Read the instructions on the package carefully. First, test on a small area to see if the product meets your needs.

Price per unit

Industrial Degreaser - Silicone Cleaner **SOTT**



*optimal
removal of
SILICONE, OIL,
GREASE, etc.*

- Harmless for car paints
- Removes silicone, grease, tar, oil, adhesive, paraffin and car importer's wax

A unique balanced product that was especially commissioned and developed some 20 years ago for use in the metal fabrication, automotive and advertising industries. Used extensively in the metal fabrication industry for degreasing prior to chroming or galvanizing. SO THIS IS A REAL DEGREASER!

T-800 Removes underbody coating, car importer's wax, paraffin, grease, silicone, etc. from all surfaces. It will even degrease through water. So having to dry a car before degreasing following a shower of rain is a thing of the past. Just apply with a cloth, wait a few minutes, and then just wipe over with a dry cotton cloth. T-800 needs to be removed with a cloth because it is somewhat slower than the volatile thinners. There's a good reason for this; for it to make grease molecules 'float' it has to first get under the molecules. So when the surface is wiped with a dry cloth, the end result is a perfectly degreased surface.

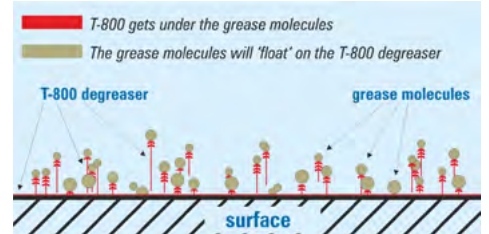

*Suitable for car paints, metal, aluminium, Beauty Board, etc.
Not suitable for use on rigid foam, polystyrene, etc.*

Every colour is accompanied by a RAL number, giving you all the information you need to make the correct colour choice.

1 L Bottle

600-T800FLES

5 L Jerrycan

600-T800CAN



Price per unit



QUICK TIPS

For installing PPF, we recommend a 2-stage cleaning system. Step 1 is SOTT SurfaceCleaner 600-SC02. Step 2 is Industrial Degreaser 600-T800.

Silicon - Wax Remover

600-T900



- The best solution for removing stubborn wax

Durable surfaces such as car paint are often treated with a protective layer. The most conventional way to do this is to use a silicone-based wax. Since silicone has a repellent effect, this is ideal to prevent dirt. However, self-adhesive materials such as stickers, strips and wrap s will also no longer be able to adhere.

To be able to do this, the wax must be removed. SOTT 600-T900 Industrial Silicon & Wax Remover ensures that the wax becomes soft and dissolves, so that it can then be removed with a soft cloth.

*Perfect
CLEANING
PREP for the
EDGES before
installing
PPF*

How to use:

1. Wash the vehicle or substrate thoroughly so that all the (street) dirt is gone.
2. Make sure the surface to be treated is dry.
3. Apply SOTT 600-T900 Silicone & Wax Remover with the SOTT 300-040 3-layer cleaning paper. This is how you do it: make a wad of paper in your hand and pour SOTT 600-T900 Silicone & Wax Remover on the cleaning paper.
4. Now polish the treatment surface thoroughly and with circular overlapping movements with your cloth. Do this thoroughly and let it soak in for a few minutes.
5. It is possible that the surface will show a white haze. This is normal. This means that the wax becomes soft and begins to dissolve.
6. Now use the SOTT 300-021 UltraClean cloth, also wet it with SOTT 600-T900 Silicone & Wax Remover and polish the surface in circular movements.
7. If the white haze (if visible) disappears during brushing with 600-T900, then the silicone and/or wax has disappeared.
8. Always polish again with a new dry cloth 300-021 or cotton/microfiber cloth.
9. Allow the surface to wash out for 10-20 minutes before you start foil mounting.



QUICK TIPS

Please read the instructions carefully before use.

T-900 is the perfect product to remove all types of auto wax, often used on tuning- or high-end cars.

Price per unit



- Removes glue from windows with two fingers in your nose
- Does not affect substrates, rubbers, rebates and interior parts
- Biodegradable

A worldwide headache cause is the removal of solar window . And we mean especially the adhesive layer. Since the adhesive applied to such polyester s is different from conventional PVC s, it often sticks hard to glass. The itself comes off the adhesive, and so the adhesive remains on the glass. On car windshields it is then completely invisible nestled into the grids, and on flat windows you have huge surfaces to strip of the hard adhesive layer. Very tedious work.

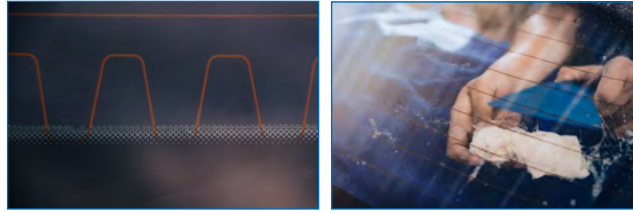

Removing adhesive from window is often a difficult job. Aggressive liquids and sharp metal scrapers are regularly used to get the glass completely clean again. From now on, that won't be necessary.

*The
30 second
adhesive
REMOVER
for WINDOW*

The SOTT Spray-N-Gone window adhesive remover is the solution for this. It simply and easily dissolves the adhesive within a few minutes. The adhesive softens and can be easily removed. Afterwards, SOTT Spray-N-Gone works as a perfect surface cleaner to leave the substrate completely 100 % clean. Does not affect anything. Completely harmless to the environment.

Instructions for use:

1. Spray the adhesive layer that remains when the window (tinting) is removed.
2. Let it soak in and use a plastic scraper or squeegee to scrape the adhesive together.
3. Use cleaning paper (300-040) to pick up the softened adhesive residue and wipe it off the surface. Repeat the procedure if necessary.
4. Then lightly spray the surface again and now clean it thoroughly with the SOTT UltraClean cloth (300-020) to leave a 100 % clean and degreased surface.



1 L Bottle

600-Z0440FLES

5 L Jerrycan

600-Z0440CAN



QUICK TIPS

- Removes adhesive from windows within minutes
- Removes grease residue, fingerprints, nicotine deposits, dirt, etc.
- Cleans glass, car paint and plastic no ADR, no hazardous substance
- Biodegradable
- No special protective equipment required can be applied with cloth, brush, roller or sprayer

Price per unit

Tint-Off Window Remover

600-TO



- 1 L bottle

Removing from car windows can pose quite a problem. Tint-Off has been developed especially for this purpose. Apply this soluble remover to the existing , cover with a piece of old or liner. After a few minutes, remove the piece of old or liner and the old window will be released with it.

QUICK TIPS

Read the instructions on the packaging carefully

Price per unit



LIQUIDS PREPARATION

Adhesive Activator - 100 ml **SOTT**

600-AA1400-100



- Neutralises surfaces containing silicone
- Harmless to the substrate

Always a pain: that releases out of recesses and channels. This could be for a number of reasons, but one of the main causes is the actual car paint.

Water based car paint: the main cause of poor adhesion.

Modern car paints may contain silicon molecules. This is obviously going to cause reduced surface adhesion. This is not normally a problem on flat bodywork panels as neither the nor the adhesive layer are under much tension. However, this tension is present in the recesses, channels and awkward corners with plastic bumpers, for example. Optimal adhesion in these areas is of paramount importance.

We all know what will happen to the if there is not a 100% adhesion.

Due to the silicone content in modern car paint, the adhesion of can be far from optimal. under tension (especially in recesses) is bound to come loose and ultimately be returned for repair or renewal.

Adhesive Activator AA-1400 appears to be the only product that successfully solves the problem of the poor adhesion of to certain car paints. This industrial grade product is also used as a bonding agent for silicone sealants on a variety of surfaces, the sealing of exposed security edges on glass being a prime example. Available in cans of 100ml.

*Eliminate
RISKS
by Improving
ADHESION*

The risks involved with water-based car lacquers:



Due to the silicone content in modern car lacquers the adhesion of can be far from optimal. under tension (especially in recesses) is bound to come loose and ultimately be returned for repair or renewal.

Damaged at the edges



Poor adhesion of full-colour prints



Application:

1. Thoroughly clean and degrease the application surface.
2. Using a cloth, apply a small amount of 600-AA-1400 to the surface and wait for approx. 15-30 minutes (depending on humidity levels).
3. Then apply the dry to the primer and voilà, a much improved adhesion to the surface.
4. Finish by following the manufacturer's instructions.



QUICK TIPS

Bonding primer for water based car lacquers

Price per unit



LIQUIDS CLEANING

Glasscleaner **SOTT**

600-GC101



- For optimal cleaning and degreasing of glass to prepare it for the mounting of tinting
- With a fresh and pleasant odour; no lingering nasty smells
- Deep-cleans and dries fast without leaving stripes.

When large shop windows or windows in or on offices are to be covered with tinting or vinyl, good bonding is of the utmost importance. No glass is perfectly smooth - the small surface irregularities are going to get dirty. New glass often has paraffin wax on the surface. Our GlassCleaner cleans and degreases glass thoroughly for installation of . Window manufacturers recommend Dirt-Off for cleaning windows before application. Contains a highly diluted 'acid' for completely removing grease, oil and dirt from glass without damaging its surface.

GlassCleaner draws the dirt out of the tiniest surface irregularities and lets it 'float', so it can be wiped away with a sponge, cloth or squeegee.

Harmless and with a pleasant odour

GlassCleaner is especially developed for regular use on large surfaces and lacks the typical offensive odour of alcohol- and ammonia-based cleaners. Also it is completely biologically degradable, non-corrosive and non-irritant. Good to know, next time you are spraying your cleaner around in a large office swarming with employees. There is no need to wear protective clothing or gloves.

Multifunctional!

GlassCleaner does more. Its formula makes it perfect as a general multifunctional cleaner for plastic boards, doors, tables tops, desks, shelves, etc

Instructions for use

Easy. Just spray the surface, if needed rub with a Scotchbrite Anti-Scratch scrub pas (300-025), then wipe away with a cloth or squeegee. Done!

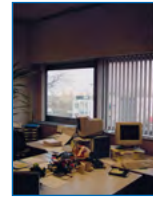

Nothing more awkward than customers or staff complaining about the bad smell caused by cleaning the windows in a home or office. No more problems with the penetrating smell of ammonia or alcohol. GlassCleaner just smells fresh and does its job perfectly. And it can be used as interior cleaner!



Windows that reach down to the carpet or other valuable floor covering are popular and good-looking. But if your cleaner bleaches or tarnishes it, there will be trouble. GlassCleaner is your multi-functional cleaner that ONLY does what it SHOULD: it cleans the applied-on surface quickly, simply and without leaving any stripes.

*The
30 second
adhesive
REMOVER
for WINDOW*

1 L Bottle

600-GC101FLES

5 L Jerrycan

600-GC101CAN



QUICK TIPS

- Suitable for cleaning:
- Large glass windows
 - Glass tables and doors
 - Acrylic, polycarbonate, etc.
 - Rigid foam
 - Objects that are coated with acrylic paint
 - Tables, doors, desks
 - Rabbets and frames

Price per unit

DIRT-OFF

600-DO



- 1 L
- As recommended by window manufacturers

Window manufacturers recommend Dirt-Off for cleaning windows before application. Contains a highly diluted 'acid' for completely removing grease, oil and dirt from glass without damaging its surface.

Dirt-Off is also ideal for use as a bonding aid to improve adhesion to the dot matrix raster and the rear windscreen demister



The windows of second hand cars or cars that have been used for transporting a dog should be cleaned with Dirt-Off before applying window .

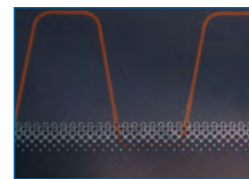

The dot matrix raster around the edge of windscreens often present adhesion problems. Dirt-Off cleans these small areas thoroughly, thus ensuring improved adhesion.

*slightly acidic
CLEANER for
car windows*

Price per unit



Surface Cleaner II SOTT



- Developed especially for professional installers of all type of s
- Cleans car paint, metal, plastic, glass, bisonyl, etc, etc.
- Biologically degradable

SOTT Surface Cleaner-II is the number one cleaner in the selfadhesive industry. It meets all of the demands of the installer; just spray Surface Cleaner-II on any surface.

It loosens the dirt and you just remove it with a dry cloth. Surface Cleaner works fast and dries during polishing. No stripes, lines or dirt getting spread around. Just grab the SOTT Surface Cleaner-II, spray, wipe with a dry cloth, job done!

This universal cleaner certainly lives up to its name: it can clean any surface, removing dirt, grease, adhesive residue, etc ready for application. This product has been developed in accordance with the latest European standards and legislation, and conforms to all current environmental requirements.

*The fast
CLEANER
for all
surfaces*

Paint, Plastic and Rubber



SurfaceCleaner-II is specially developed to, thoroughly and quickly, get a perfectly clean and grease-free surface on all types of vehicle substrates – paint, plastic and rubber. No whitening or burning of the clear coat. The mixture of special ingredients removes grease, grime, wax and adhesive residue at the molecular level.

Windows



Before you start installing window , etch glass or vinyl lettering, you want to make sure the surface is completely clean. You'll be amazed at how effective and fast SurfaceCleaner-II does its job! It seeps under grease and dirt molecules that results in an easy wipe off and it evaporates quickly.

Signshop Workhorse



Plastic sheets, advertising signs or banner material? No worries. The multi-talent product called SurfaceCleaner-II is designed to be suitable for all types of applications.



QUICK TIPS

Suitable for cleaning:

- Large glass windows
- Glass tables and doors
- Acrylic, polycarbonate, etc.
- Rigid foam
- Objects that are coated with acrylic paint
- Tables, doors, desks
- Rabbets and frames



QUICK TIPS

WE RECOMMEND:

For installing PPF s, we recommend a 2-stage cleaning system.



Step 1 is SOTT SurfaceCleaner

600-SC02



Step 2 is Industrial Degreaser

600-T800

Trigger Sprayer

600-SC02FLES



Trigger sprayer each

Price per unit

Jerrycan

600-SC02CAN



Contains 5 L

Price per unit

Trigger Sprayer

600-SC02



Box of 6 pieces

Price per unit

Drum

600-SC02VAT



Gross volume 200 L

Price per unit

The Trigger

550-200



- Especially for the use of liter bottles

Since different liquid products are delivered without a nozzle, it can be ordered separately.

Price per unit



CLEANER for MATT and GLOSS car wrap

- The Number One cleaner for matt and gloss s

Car wrapping is really HOT at the moment, especially the matt colours. However, it won't have escaped the notice of car wrappers how much more difficult coloured matt s are to clean than coloured gloss. Why is this?

It's the dimples in the

Matt s are somewhat structured with minute 'dimples' that deflect light to give it the matt appearance. These dimples collect street grime that is difficult to remove with ordinary cleaners.

Road salt, exhaust vapour and brake dust

Normal street grime is nowhere near as stubborn as the road salt used during the winter, especially when it's combined with asphalt and rubber. Add to that the steam from hot engines and the underside of cars that spreads to the sills and spoilers. Not to mention the dust from disc brakes that escapes through the wheels and clings to side of the car. This is a common problem especially with sports and executive models. These models are much closer to the road and the dirt; they tend to be driven faster, so the brake shoes are subjected to more wear, etc.

What does Carwrap Cleaner actually do?

Carwrap Cleaner loosens the dirt between the dimples and 'suspends' it until it's removed from the surface. The supplied car wrap sponges absorb the dirt preventing it from returning to the dimples. Then just rinse with clean water - job done!



Fashionable light colours such as matt white, matt silver or matt grey are notoriously difficult to clean.

A winter of road salt, a rainy day, or simply brake dust or exhaust vapour all present problems.



The car wash, steam cleaners or ordinary cleaners only remove surface dirt, and they always leave a dark haze on the .

QUICK TIPS

Don't!: Never use thinners, degreasers or surface cleaners for removing dirt. This will increase the problem much more.

Just do!: A great seller to add to your range! Your car wrap clients can maintain the perfect look themselves if they purchase a Car Wrap Cleaner set.

After Car Wrap Cleaner

Conventional washing

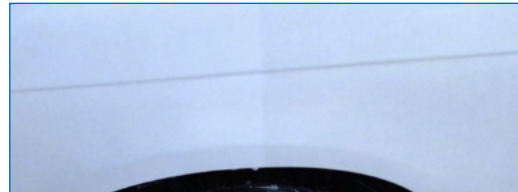

This Opel Astra speaks volumes. After not being washed for 3 months, this car was cleaned using the conventional method. Only the surface dirt was removed. At first sight, it looks fine. Only when the left hand side has been cleaned with Car Wrap Cleaner is the difference suddenly apparent.



This Astra speaks volumes. After not being washed for 3 months, this car was cleaned using the conventional method. Only the surface dirt was removed. At first sight, it looks fine.

Price per unit



LIQUIDS PROTECTION

Solar Varnish - Heat Protection Coating 5 L

600-SV5



- Blocks up to 85 % of the sun's heat (IR)
- 5 L can

Solar Varnish is an alkyd resin-based translucent white heat resistant coating that can be simply applied to glass, polycarbonate and acrylic. This coating blocks as much as 85 % of the sun's heat. Ideal for skylights in factory buildings etc. Solar Varnish contains reflective particles that reflect both UV and infrared light. In addition, the absorption is low, so there will be little radiant heat. The coating is translucent matte, so it is not transparent. The result after application is a milky white, translucent layer. The best installation temperature (environment) is 10°-15°. Do not apply during rainy, foggy or wet weather. Lifetime 8 years (horizontal: 3-4 years).

Technical information:

Visible light transmission: 25 %
 Solar energy protection: up to 85 %
 UV protection: 90 %
 Glare reduction: 80 %
 Absorption: 10 %
 Consumption/capacity: 30m² (2 layers)

**SOLAR
REFLECTIVE
PAINT**

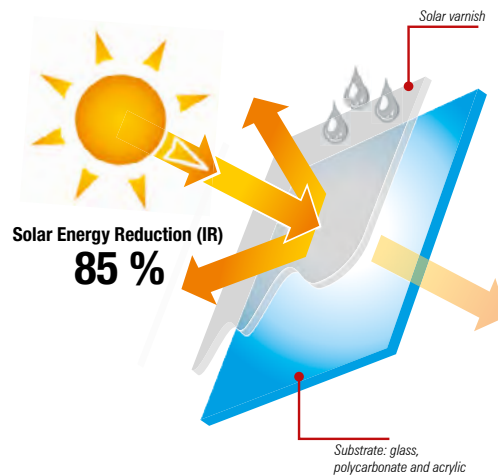
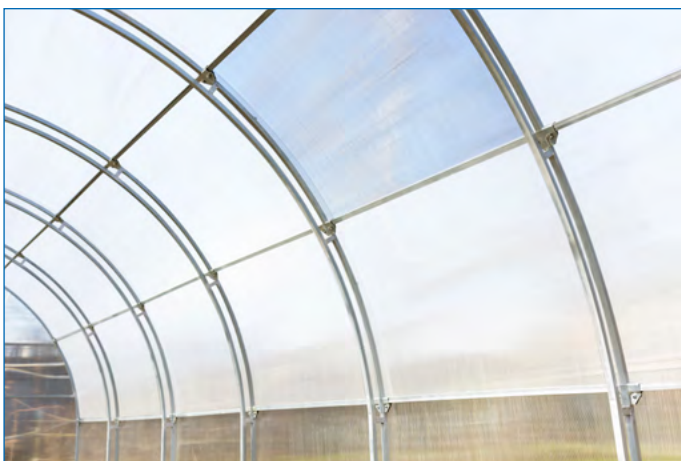

Instructions for use:

1. Substrate must be degreased and clean.
2. Can be applied by spray (for best result), brush or roller. Apply 2 layers.
3. Dilute the first layer with 50 % white spirit.
4. After 2 hours, the second layer (undiluted) can be applied. More information is enclosed in the package.

Price per unit

Window Polish

SOTT

600-GP346

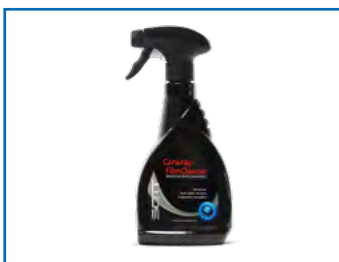

- Gives the a protective sheen
- Offers an extra protective layer between the and the window reveals.
- For interior use only

After the application of window , the top layer often displays stripes and matt areas. These are just harmless traces of lime from the application fluid or simply small areas of dirt left by the squeegee. After a while, the on wind-up windows may start to get scratched or scuffed by the dirt in the seals and felt in the window rebates. This can be fixed.

-Polish brings back the shine and leaves the sparkling, as well as giving it a dirt-repellent protective layer. Window in cars Ideal for use on the window on wind-up windows, as the smooth protective layer allows the to run more smoothly between the seals and the felt in the window rebates. This will prevent scratches. Window in buildings -Polish gives large windows an impressive sheen as well as a dirt repellent layer. Not only that, after the has been polished it has an incredibly 'clean and tidy' appearance - great for customer satisfaction!



QUICK TIPS

A great seller to add to your range !
 Your customer can maintain that perfect look of the tinted glass themselves if they purchase a bottle of 600-GP346 Window Polish.

Price per unit

LIQUIDS INSTALLATION

On - Slip Agent for Window and PPF

SOTT

600-F0355



- Improved moisture distribution
- No more white haze or spots after application
- Easier positioning and squeegeeing
- Also useable as slip agent for ppf

-On is the window tinter's friend and ppf's installers compaignion. It has unique properties not found in any other slip agents. It still has the edge on all other products on the market.

A colourless jelly-like concentrate for dilution in water. Just add a little to water, give it a quick shake and it's ready to use.

-On evaporates faster, and has a glutinous property that increases the viscosity of the solution. When it's sprayed on to glass, it stands firm unlike the soap and water solution that just cascades back down the glass.

You will notice immediately how much easier it is to slide the . The solution between the glass and the is softer and thicker which makes squeegeeing a lot easier.

White stripes and moisture build-up between the and the glass during drying is also reduced (common with safety) - a big plus! Adhesion is vastly improved.

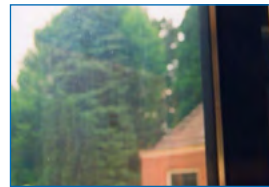

A white haze or a collection of minuscule air bubbles is caused either by poor execution or by the reaction between the moisture and the adhesive layer of the . -ON almost eliminates the chance of white haze.

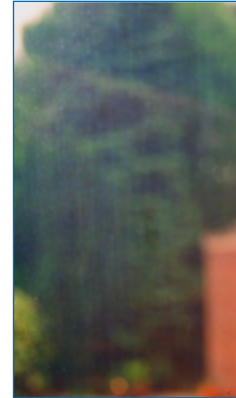

Price per unit

*Window
and PPF
application
made EASIER
than ever*

Slide-On™ Mounting Lubricant For Windows - 500 ml

SOTT **NEW**

600-F02



THIS EUROPEAN VERSION IS SIMILAR TO THE FAMOUS ON, BUT HAS MORE ADVANTAGES

*The new standard
in the window industry*

Improves and works faster than other concentrates.

Slide-On is the new standard!

The colourless gel mixes with water and increases its viscosity so that it spreads nicely over glass during spraying. A small layer with sliding properties is literally sprayed onto the glass. This allows window to slide and position easily. But there is another reason why TM is interesting. It slides on foams like soap, but disappears very quickly! And it should, because foam contains air, which is exactly what we don't want under the . When the soap property disappears after positioning and racking the , the adhesive layer does its job and starts the adhesion. No hazardous substance. Biodegradable

Instructions for use:

- Add 6-10 ml Slide-On™ to 1 liter of water. Shake and ready to use.
- Dosage amount depends on the ambient temperature. You can increase or decrease dosage as required.
- Always make sure spray tools are clean and clean any filters in the nozzle before starting..

How to dose.

- The bottle contains a small dosing chamber.
- This contains a measuring dosage in ml.
- Unscrew the cap of the dosing chamber. Now squeeze the bottle and through the small tube on the side, the concentrate will move up and fill the dosing chamber.
- Gently squeeze until the desired amount of concentrate has reached your targeted measure. Now you can pour the concentrate out of the dosing chamber without any problems.

*Window
and PPF
application
made EASIER
than ever*



Window Automotives



Window Architectural Residential



- Leaves no residue in spray bottles or tanks
- No white haze or air bubbles under the
- Slide, position, touch and go!
- Foam disappears quickly
- Box of 6 bottles of 500 ml

600-F02

500 ml

Price per unit





This product works better and faster than other concentrates, ensuring a dust-free area. It acts as an antistatic, cleaning, descaling, degreasing, disinfecting, and sanitising cleaner for glass surfaces, mirrors, and stainless steel, ensuring a long-lasting shine.

Directions for use:

- Spray the undiluted product onto the surface to be cleaned.
- Leave on for a few seconds.
- Wipe with a clean cloth or squeegee suitable for the surface.

Relevant identified uses:

- Cleans, descales and degreases glass and stainless steel surfaces (windows, showcases, refrigerated display cases, stainless steel worktops, etc).
- Removes dust, dirt and fingerprints without leaving residue.
- Suitable for all smooth surfaces.

essential for E-FILM installation



Safety instructions:

- Do not spray on hot surfaces or in flames
- Do not mix with detergents or acids
- Avoid direct contact with eyes
- Preferably use at temperatures between 5°C and 28°C
- Store at temperatures not exceeding 28°C
- Protect from freezing
- Only store in the original container
- Keep tightly closed



Perfect for use with:



300-040

Composition:

- Ultrapure water
- Caprylyl Capryl Glucoside
- Cetrinonium Chloride 29
- co²-mango extract
- co²-coco extracts
- Ligitint Royal HF

Benefits:

- Alcohol free
- PH neutral
- Non-aggressive to the epidermis
- Biodegradable
- Non-inflammatory
- Organic surfactant
- Solvent free

Price per unit

Right-On Spray - Application Liquid



- **Faster than soap and water**
- **Easy to use**
- **3 minutes to position and make adjustments before adhesion starts**

The perfect solution for fast and effortless application of self adhesive s without air bubbles and wrinkling. Right-On allows the to be repositioned after initial application.

It offers all the advantages of soap and water, but it works faster. Spray the substrate and adhesive layer of the , apply the and slide it effortlessly in to position. The begins to bond after just 3 minutes and you can even start working it into channels immediately.

Right-On Spray will not affect the adhesive layer. Suitable for use on all types of wet application .

The one and only 3 minute APPLICATION LIQUID

Quick and easy installing of PPF

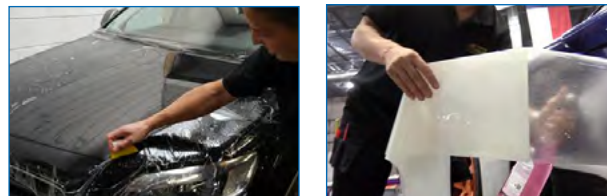

Right-On Spray is suitable and effective solution for PPF. It gives the installer the freedom to position and readjust which allows them to install with confidence. And because of the special ingredients in Right-On Spray, the final adhesion level is even improved when compared to other liquid carriers.

Oversaturated or Aggressive Full Print Wraps



Printed sometimes feels different, has harder tack and can be tough to install (especially when the panels are big). This is often caused by s that haven't properly outgassed or are oversaturated. Heat and humidity can also cause full print wraps to grip overly hard. Right-On Spray was made for just these situations. Simply spray, position, squeegee and you're done!

Hot garage? Sticky ? No Problem



On warm days, even the friendliest wrap can get aggressive which can cause install times to shoot up as well as frustration levels. Using a thin mist of Right-On Spray on both the surface and adhesive can help that panel slide and glide. The unique blend of Right-On Spray won't compromise the adhesive so it's safe for all brands.



This product has been developed in accordance with the latest European standards and legislation, and conforms to all current environmental requirements.

1 L Bottle

600-Z0314FLES

5 L Jerrycan

600-Z0314CAN

200 L Drum

600-Z0314VAT



Price per unit

PROMOTIONAL TOOLS

Today's customers often know exactly what they want. But how do you convince your customer that you can offer them the best? That you have exactly what they need? Our support materials will help you do just that. For each specific topic, we have something that can help you with your sales or your presentation.



PROMOTIONAL MATERIALS to convince your customer

Window Demo Box with 250V IR lamp

750-WFDB



- Seeing and feeling = believing! Let the customer experience the result himself
- Turnable box with four glass panels

The Window DEMO BOX is intended to convince your customer that window really works.

The box consists of a base with a turnable unit on top with four glass panels that can be tinted with window as desired. Press the button and the 250 watt IR lamp turns on. The different types of window on the glass panels allow your customer to clearly feel the difference in heat protection.

Our advice: leave one glass panel free of window, so that the difference with and without can be experienced very clearly.

220 V DEVICE EUROPEAN POWER CORD

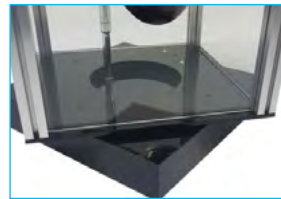

QUICK TIPS

The DEMO BOX is made of high-gloss acrylic. The glass panels can easily be changed by taking off the lid. The lamp is operated with a switch, which switches off automatically after 2 minutes.

Price per unit

Window Performance Box - Metal Case

750-WFP



- Seeing is believing!
- Convince your customer within 1 minute

The WINDOW PERFORMANCE BOX immediately shows the heat difference between two windows and the temperature difference in both compartments. The ultra-strong metal case contains two compartments with a 150 W infrared lamp inside. Each compartment contains a sensitive temperature gauge and fan at the bottom. Between the lamp and the temperature gauge a glass plate with window is placed*. Press the button and the lamps turn on. The temperature rises in both compartments, which can be read on the lower digital displays. The upper digital displays indicate the temperature difference between the ambient temperature with- and without the placed glass plate with window.

After 1 minute the unit switches itself off.

Digital display shows temp difference

Digital display shows compartment temp

150 W IR lamp

Place your glass samples here

Winds

Temperature gauge
Metal case



Fans that cool the compartment after each measurement.



Digital displays for clear information. Temperature gauges in Celsius



Operates on 220 V. European plug. CE certified.

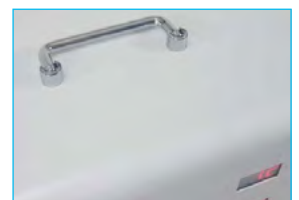

Full metal housing, painted and neatly finished.



QUICK TIPS

*Glass plates are not included. You need to purchase these yourself. Recommended size: 16,5 x 16,5 cm.



**IDEAL FOR NANO CERAMIC
AUTOMOTIVE TO SHOW
THEIR EFFICIENCY**

Price per unit

UV Sentry Transmission Meter - Digital

750-WFUV



- Convince your customer with this meter
- Handy; operates on 9 v battery (included)
- Measures UV-A

The UV SENTRY is probably the simplest meter available to measure the amount of UV in the spectrum from 325 nm to 385 nm that passes through a transparent material. The meter measures transmission accurately to 0.1 %. The digital display is constantly updated with real-time measurements. Make an impact and convince your customer by illustrating the UV blocking properties of your product.

The meter can calculate the actual UV Transmission percentage of a given material. The UV SENTRY can be used to measure the UV characteristics of glass, coatings, laminates, or other materials. Use this meter to make convincing sales presentations. The UV SENTRY can effectively promote your UV-blocking products.



QUICK TIPS

The meter works best with adequate UV light. During a cloudy day, the meter may not be able to detect the sun's rays sufficiently.

Price per unit

Light Meter - In Lux

750-WFL



- Measuring range: 0.01 - 50,000 lux
- Comes in storage bag

This digital light meter is a very precise measuring instrument with which the light intensity in a certain environment can be measured. After the measurement, you know exactly what to do when, for example, window shades are applied to exterior windows and the incoming light is reduced.



This can be hugely important, because rooms used by people must comply with a certain amount of light (indicated in lux), to perform optimally or live healthily. For example, the light in a waiting room should average 250 lux. For offices and laboratories 500 lux. For workshops, 750 lux. And for technical drawing, precision work and color assessment 7000 lux. The measurement is made via a photo element and is then displayed on the screen.



QUICK TIPS

Batteries included.

Price per unit

Solar Transmission & Power Meter

750-WFBTU



- Use this meter to evaluate solar performance.

It provides excellent resolution, reading low light conditions more accurately than competitors, with no need for adjustments. The easy to read digital display toggles between power and transmission percentage mode. It's small, portable, and convenient to take out in the field. Can be switched to read in metric units.



QUICK TIPS

Powered by a 9-volt alkaline battery (included).

Price per unit





- 3 Devices in one case
- No more guessing and doubting

What kind of glass should you quote with? Is it single glass? Double? Triple? Is there a Low-E coating perhaps? How large is the distance between the multiple panes of glass? All important if you want to avoid problems like thermal breakage or wrong choice.

As of now, you have a solution.

This professional kit contains all the gauges you need to know what type of glass you are dealing with. Often, your customer himself does not know what kind of glass he has in his building. Now you can check yourself and make your decision. Indispensable for every professional window installer.

THIS IS WHAT YOU GET:



Toughened glass indicator

Several types of window can often be mounted on tempered glass. But then you need to know if that is really the case. This indicator shows you exactly that. Vertical lines appear in the window when you are dealing with tempered glass. 2 lines when it is single glass tempered and 4 lines when you are dealing with double glass tempered.



Glass thickness and glass distance meter

This gauge shows exactly how thick the glass is, even when it is made up of several sheets of glass. It also measures the air gap between the glass panes. The following glazing's can be identified by this meter: where it is.



Low-E coating detector

Some types of glass have an invisible insulating and energy efficient factory coating. But which side is it on? Inside, outside or in between? This meter detects the coating and indicates where it is.

- SINGLE GLAZED
- DOUBLE GLAZED
- COATED DOUBLE-GLAZED (LOW-E ETC.)
- TRIPLE GLAZED
- LAMINATED SAFETY GLASS
- LAMINATED FIREPROOF GLASS (ALSO MULTIPLE LAYERS)



Price per unit





- Hard plastic
- 14 cm round and 3 cm high

The hard plastic SHAPE has everything to showcase a colour at its best. The round shape is convex, concave and also contains sharp kinks, so that the applied colour shows to full advantage in every light and at every angle of vision.

showcase your vinyls in the perfect way

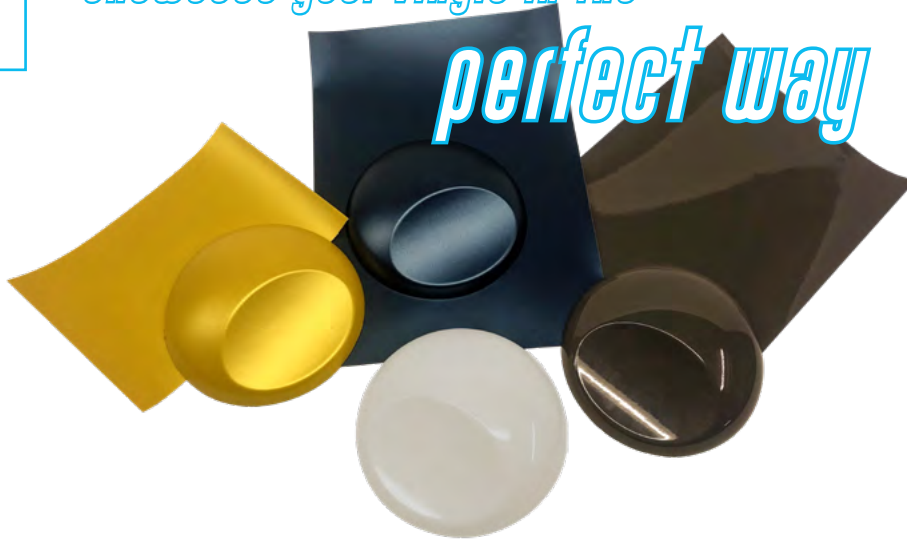

How can you demo your color selection in a beautiful and perfect way ? Display swatches of vinyl ? Only use a color chart ?

These white, plastic car shapes are hollow, lightweight and designed specifically for vinyl wrapping so their colors are shown in the best way possible. Your customer will get a better impression of how the vinyl looks on a curved shape instead of a small swatch out of a color collection.



Price per unit





- A must for every architect, designer and sign maker.
- Including 17 metallic colours and 6 fluorescent colours.

The official colour fan consisting of 210 standard RAL colours. All colour definitions of paint, lacquers and coatings as used in the construction industry available in one fan.



RAL COLOUR FAN

RAL COLOURS ARE THE COLOUR DEFINITIONS OF PAINT, LACQUERS AND COATINGS AND ARE USED AS THE INDUSTRY STANDARD IN ARCHITECTURE AND CONSTRUCTION THROUGHOUT EUROPE.

Price per unit

Box *NEW*

KIT BOX



- Boxes with bottom and lid

Available:

51 CM	101 CM
61 CM	122 CM
76 CM	152 CM
91 CM	183 CM

51 cm	Price per unit
61 cm	Price per unit
76 cm	Price per unit
91 cm	Price per unit
101 cm	Price per unit
122 cm	Price per unit
152 cm	Price per unit
183 cm	Price per unit

Tube *NEW*

TUBE



- Recycled cardboard
- External width 8.4 cm; Internal width 8 cm;
- Thickness 2 mm

Available:

122 CM
152 CM
183 CM

122 cm	Price per unit
152 cm	Price per unit
183 cm	Price per unit

Carton End Cap *NEW*

CARTON END CAP



- Recycled cardboard



Price per unit



COVER STYL TOOLS

Get the job done professionally with our range of Cover Styl vinyl preparation and application tools. Our tools have been specially designed to offer you a precise and efficient job, allowing you to handle the vinyl easily without the risk of damaging it. In addition, our selection of tools will allow you to work faster, for a perfect result in no time.



OMEGA 13 Squeegee **SOTT** *NEW*

150-LM13



- Extra wide: 13 cm

Same product as OMEGA 10 but extra wide: 13 cm.



Flexible and malleable

The OMEGA Squeegee follows all surface contours and curves impeccably.

Stiff and sturdy

The OMEGA Squeegee by SOTT is made of a rubber/plastic composite that makes it stable and exerts good counter pressure when you are power squeegeeing.



QUICK TIPS

is your squeegee no longer straight and smooth due to wear and tear?



350-210

Price per unit

CS Squeegee 13 cm *NEW*

150-CS13



By taking the best features of existing squeegee, we created the perfect one for interior decoration in PVC free!
13cm, hardness: rigid, one 90° angle



QUICK TIPS

Compatible felt pad:



150-CFS-13

Price per unit

Felt Pad 13 cm *NEW*

150-CSF-13



Felt pad in 13 cm for longest durability.
Designed for interior installation where a stronger resistance is required.



QUICK TIPS

Compatible with:



150-CS-13

Price per unit

Time Saver 65 cm *NEW*

150-CS65

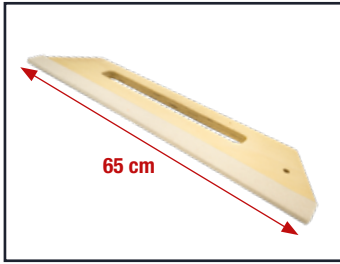

Apply Coverstyl on flat surface has never been so easy! For kitchen doors or small panels, doors or big panels we created 2 squeegees in 65 cm and 100 cm.

With a certain angle, they will automatically remove the backing paper from the vinyl during the installation.

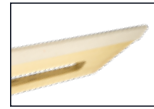

QUICK TIPS Compatible felt pad:  500-065

Price per unit

Time Saver 100 cm *NEW*

150-CS100

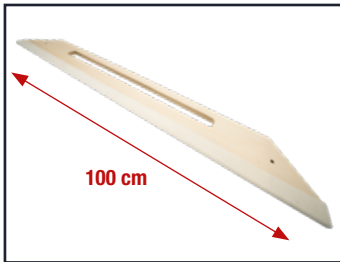

Apply Coverstyl on flat surface has never been so easy! For kitchen doors or small panels, doors or big panels we created 2 squeegees in 65 cm and 100 cm.

With a certain angle, they will automatically remove the backing paper from the vinyl during the installation.



QUICK TIPS Compatible felt pad:  500-100

Price per unit

White Felt Pad 65 cm *NEW*

500-065



White felt pad in 65 cm

QUICK TIPS

Use with:



150-CS65

Price per unit

White Felt Pad 100 cm *NEW*

500-100



White felt pad in 100 cm

QUICK TIPS

Use with:



150-CS100

Price per unit



COVER PRIMER+ Solvent-Based

- Clear solvent-based primer for interior s
- Available in 250 ml and 1 L

Adhesion primer from Cover Styl, for the application of interior s on edges and corners where adhesion must be guaranteed and optimal. Adheres to smooth and lightly structured non absorbent surface. Think of furniture panels, glass, painted wood, doors, hard plastic, car paint, etc. This transparent solvent-based lacquer lays down a permanent thin layer over the desired surface. Ensures adequate ventilation during use.

250 ml Can

600-PMR250



Drying time: 15-20 min.
Capacity 250 ml: 7.5 - 10 m².

Primer Plus + is a solvent-based primer for use on a non-absorbent surface where you apply Cover Styl interior . Just around the perimeter + edges, giving a line of 0.3 mm and 0.5 mm

Price per unit

1 L Can

600-PMR1000



Drying time: 15-20 min.
Capacity 1 L: 30 - 40 m²

Primer Plus + is a solvent-based primer for use on a non-absorbent surface where you apply Cover Styl interior . Just around the perimeter + edges, giving a line of 0.3 mm and 0.5 mm

Price per unit

Primer + Stick or Primer Pro Stick

NEW

600-PMR40



Empty Primer+ stick is designed to easily apply the Primer+ on the perimeter of the surface without touching it with your skin but also applying the right quantity to reduce smell and excessive quantity.



QUICK TIPS

Use with:



600-PMR-APP

Price per unit

Mohair Applicator for Primer + Stick

NEW

600-PMR-APP



Use with 600-PMR40

Price per unit

Cover Primer - Water Based

600-P1000



Water-based adhesion primer from Cover Styl, for applying interior s and other s to absorbent surface and difficult to adhere substrates such as untreated wood and plaster. Not intended for smooth surfaces such as furniture panels, glass, smooth painted doors, etc.

Drying time: 60 - 120 min.
Capacity: 25 sqm

Price per unit



Cover Styl



HIGH TACK BOND PRIMER

- Outstanding performance on absorbent surfaces
- Maximum yield

High tack bond Primer is created to have the maximum adhesion on absorbent surface such plaster or MDF board. The product must be diluted 1:1 with water except for the perimeter where it can be applied pure

1 L

600-P1000N



Drying time: 60-120 min.
Capacity: 1lt. : 50 sqm*

(*) Product diluted

Price per unit

3L

600-P3000



Drying time: 60-120 min.
Capacity: 3 lt. : 150 sqm*

(*) product diluted

Price per unit

Primer Pro **NEW**

PMR-1000-PRO



Primer Pro + an ISO alcohol-based solution that optimizes the adhesion of adhesive s on multiple substrates such as laminated/melamine surfaces, raw metal surfaces and surfaces that have undergone treatments (galvanizing, anodizing, etc...), as well as on surfaces painted with synthetic polymers with a high degree of cross-linking (epoxy coatings, polyurethane, powdered paint, varnishes, etc.).

Drying time: 2 min.
Capacity 1 liter: 30 - 40 sqm

Price per unit

Primer Pro **NEW**

PMR-250-PRO



Primer Pro + an ISO alcohol-based solution that optimizes the adhesion of adhesive s on multiple substrates such as laminated/melamine surfaces, raw metal surfaces and surfaces that have undergone treatments (galvanizing, anodizing, etc...), as well as on surfaces painted with synthetic polymers with a high degree of cross-linking (epoxy coatings, polyurethane, powdered paint, varnishes, etc.).

Drying time: 2 min.
Capacity 250 ml: 7.5 - 10 sqm

Price per unit

Mastic **NEW**

600-MCS



Bi-component filler for the preparation of wood-based, metal surfaces generally used for all hard substrates requiring high final definition.

It dries quickly and allows the filled part to be worked on after a short time.



QUICK TIPS

Use with:



150-CSP-6



150-CSP-13

Price per unit

Spatula 6 cm **NEW**

150-CSP-6



Use with 600 MCS

Price per unit

Spatula 13 cm **NEW**

150-CSP-13



Use with 600 MCS

Price per unit

OLFA® Professional Cutter *OLFA*

100-SVR-2



- Autolock; for 45° blades

The most famous professional cutter. Stainless steel holder with auto lock system.

QUICK TIPS Recommended knife blades: 120-AB10, 120-AB50, 120-AB10S, 120-AB50S, 120-ABB50

9
mm



Price per unit

OLFA® Professional Cutter *OLFA*

100-SAC-1



- For 30° blades

Stainless steel cutter with 30° angled blade for precision work. Without auto lock.

QUICK TIPS Recommended knife blades: 120-SAB-10, 120-BD100

9
mm

Price per unit

OLFA® Cutter Ultra Sharp *OLFA*

100-FWP-1



- Thinner blade

Wallcovering cutter with a thinner and sharper blade.



QUICK TIPS Recommended knife blade: 120-FWB-10, 120-FWB-50

12.5
mm

Price per unit

OLFA® 9 mm Stainless Steel Snap - Off Blades *OLFA*

120-AB-S SERIES

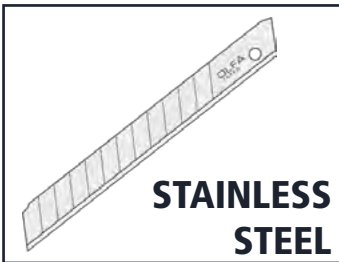

- High quality stainless steel blade for use in moist environments
- Don't scratch on glass

The blades ideal for use in moist environments (wallpapering, window s, etc.) where rust is a concern. This blade made from high quality steel is produced using OLFA precise multi-step production process for unparalleled sharpness and superior edge retention. Long lasting, durable snap-off blade - a new sharp edge with each snap. 13 cutting edges per blade.

- **MADE FROM STAINLESS STEEL**
- **DOUBLE-HONED BLADE PROVIDES SUPERIOR INITIAL SHARPNESS AND EDGE RETENTION**
- **EXACT 59° EDGE ANGLE OPTIMIZES CUTTING POWER AND MINIMIZES BLADE BREAKAGE**
- **FITS OLFA PRO 9MM UTILITY KNIVES**



120-AB-10S
120-AB-50S

10 ultra sharp medium size blades in a plastic case
50 ultra sharp medium size blades in a plastic case

Price per pack
Price per pack

OLFA® 30° Snap - Off Graphics Blades - Super - Sharp *OLFA*

120-SAB-10

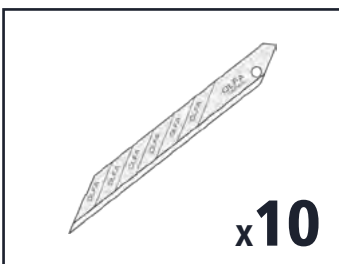

- 10 Blade pack
- 7 Snap-off edges per blade

Standard-duty acute angle blade for use in a multitude of applications. This blade made from high quality carbon tool steel is produced using OLFA's precise multi-step production process for unparalleled sharpness and superior edge retention.

- **ACUTE 30° ANGLE**
- **7 SNAP-OFF EDGES PER BLADE**



120-ASB-10

10 blade pack

Price per pack



- **Bigger Handle**
- **Powder coated pedestal to avoid sticking adhesive**

Glides perfect between vinyl and paper liner. Foot is coated so it won't stick on the adhesive side. The handle is longer than conventional slitters and provides better grip.



INCLUDING 5 EXTRA BLADES



QUICK TIPS

Recommended knife blades:



120-023R

Price per unit



- **Cut only the top or bottom layer with precision**
- **6 depth settings**

This handy slitter from NT is ideal for cutting to a specific depth with precision. Cut adhesive without touching the backing paper/supporting material, or, cut the carrier without touching the . It is all possible with this slitter.

The depth is adjustable to 6 different positions. The blade in the plastic housing is made of superhard Tungsten Carbide and provides a perfect cut. The blade is not replaceable.



Price per unit



- **Install over rivets, in channels and on bricks in no time!**

The well-known RollePro is the only tool that really works for installing around rivets and applying wall s to brick or stone walls. The RollePro has a hard foam wheel that presses the into and around curved or uneven surfaces. Install the over the surface, warm it up and roll the RollePro over the shape or surface. Keep pressing firmly until the has cooled off, then heatfix and you're done.

Price per unit



- **150 mm (6") wide**
- **Top-heavy version; with bearings**

Professional roller mounted in ball bearings and intended for intensive use. Top heavy means that the actual rubber roller is the heaviest part of the tool allowing extra pressure to be exerted during application procedures. This is especially evident during the application of large areas of . Less pressure needs to be applied as the roller does most of the work.

Price per unit



- **Aluminium frame**
- **Medium soft rubber wheel**

Special pressing roller for installation of s in channels and trenches in vehicle bodywork. The advantage of a roller over a squeegee or rubbing with a glove, is that the (heated) does not poach. A roller pushes the everywhere evenly into the trench without moving it.

Tiles is not an easy surface to cover, especially when you must conform the inside the joints. Here a tool that will help you out during this installation

Price per unit

STEINEL® Heat Gun Digital 2200 W - Soft STEINEL**400-HL2020E**

- Perfect for sign makers and installers

Electronic adjustable temp. settings with memory. Infrared scanner is optionally placeable on top.

- 3 AIR FLOW SETTINGS
- 80 - 630 °C
- 2.2 M CABLE

Price per unit

STEINEL® Heat Gun Expert - 2200 W + Extra Long Cable STEINEL**400-HG2120E**

- Perfect for sign makers and installers

What a misery! On conventional hot air guns the power cord is too short, so many a times the plug gets pulled from the outlet when you are using it. This Heat Gun eliminates that problem. It has a 7.5 meter long industrial neoprene power cable.

Advantages: always flexible, better heat resistance and no more need for an extension cord.

- 3 AIR FLOW SETTINGS
- INFINITELY ADJUSTABLE TEMPERATURE SETTINGS FROM 80 - 630 °C
- 7.5 M CABLE

Price per unit

STEINEL® Heat Gun Expert - Battery STEINEL ^{NEW}**400-HG2120EB**

How many times does the heat gun cable get stuck around the tires of a car or maybe a scaffold?

Here's the heat gun with a battery that allows you to work nimbly without worrying about unplugging and replugging cables from electrical outlets.

- NO CABLE - HIGH-POWER - DIGITAL DISPLAY SETTING
- 50 - 500 °C

Price per unit

STEINEL® Battery for Heat Gun Expert STEINEL ^{NEW}**400-HGBAT**

Battery for heat-gun 400-HG2120EB

Price per unit

STEINEL® Infrared Temperature Scanner STEINEL**400-HLSCAN**

- Insurance cover for temperature
- Sensitive workpieces.

Temperature scanner HL Scan monitors workpiece temperature by a beam of LED light. An acoustic and visual signal warns the user when temperature exceeds or falls below the permissible limit. For the 400-HL 2020E and 400-HG 2120E.



Price per unit

STEINEL® Guard Cage STEINEL**400-HLGUARD**

- Protect yourself and the material
- specially for Steinel hot air tools

This heat-resistant guard cage is easily slid onto the hot air tool and helps prevent burns to both the user, as well as material burns. An ideal tool for car wrappers, window tinters and interior fitters.

The protective cage is made of heat-resistant plastic and is assembled in no time. It can also be used in conjunction with the HL Scan temperature scanner. Can be attached to HG 2320 E, HG 2120 E, HL 2020 E, HL 1920 E and HL 1820 S hot air tools.



Price per unit



STANLEY® Max Tape Rule - Professional **STANLEY**

A valuable addition to your tool kit and a sheer relief: finally you will be able to easily measure height without the blade bending due to wind or stand-out. You will be able to measure the length of an advertising board, neon sign or trailer, knowing the blade will stay straight and won't fall off the edge. These STANLEY tape rules are exceptionally sturdy, finally meeting the every-day needs of window installers and signmakers.

STANLEY® Leverlock Tape Ruler - 3 m **STANLEY**

350-RM3



This professional-standard STANLEY tape rule is perfect for any type of work, thanks to its handy size and the fact that the blade, once extended, is automatically locked.

- Shockproof case
- Blade does not automatically recoil when extended
- Simply press the button and the blade retracts
- Polymer coated tape
- Bi-material case made of soft elastomer
- Tru-Zero hook allows for exact inside and outside measurements
- Belt clip
- Accuracy: class II

Price per unit

The Yellow - 5® Cutting Ruler **SOTT**

YELLOW-5



Anti-slip cutting ruler, indispensable for signmakers, window tint installers and interior installers, that need to cut straight lines without the cutting ruler sliding all over the place.

A unique solid aluminium cutting ruler with all of the advantages that you could possibly wish for: strong, stable, straight, but above all safe. This allows you to make long cuts with ease, without the fear of the knife 'jumping' and running across your fingers. The workshop becomes safer and production is increased. Large sheets of and thick, rigid materials can now be cut with ease.

250-CB50	50 cm	Price per unit
250-CB100	100 cm	Price per unit
250-CB155	155 cm	Price per unit
250-CB200	200 cm	Price per unit

5 - Way Tool

150-035



Helper for holding window adhesive taut on windows at edges and corners during cutting. This grey version is made of soft pliable plastic and has rounded corners, so that the window will not damage when slid or placed in a corner.

These are the 5 possibilities of using the 5-way tool:

Price per unit

The Factotum - II **SOTT**

150-095



- The solution for small corners, holes, seams and cracks
- Unbreakable material

Every mechanic knows it: mounting self-adhesive in places that are hard to reach. The Factotum-II is a handy mini oval with two usable sides. It guides every in the smallest corner or kink, without destroying the while pressing. The smooth rounded corners give you the perfect opportunity to guide the to where you want it.

Medium stiff and unbreakable.

Price per unit

The Finisher **SOTT**

150-101

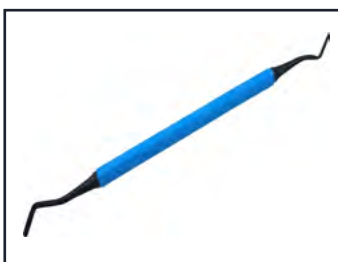

- Press down in the smallest little areas
- 2 Different spoon positions
- Coated metal spoons

A must-have for every installer. This pen-style tool has two smooth metal spoons, each at a different angle. The spoons are flat to allow for to be expertly pressed down in otherwise unreachable places. Think of corners of car hoods, between rear lights and headlights, around grilles and door handles.

Price per unit



- Set of 5 pieces
- Ideal for pressing and guiding in trenches
- Prevents cutting your fingers
- Cut resistance level 5

An alternative to a complete wrap glove.

Wrapping gloves are now fully established. But why should the WHOLE hand be covered with fabric if you often only use your fingers to push the into the channels and kinks? Also: using a glove to grip the 's adhesive layer is not always wise; fibers and dust can stick to the adhesive layer from the glove. And we don't want that.

Simply place the Little Willies on just a few fingers. Use these fingers to press on the and the other to grip the and adhesive layer. Pretty as it can be. Comes in one size; elastic fabric.



Price for 5 pieces



- Meets the ASTM/ANSI test: Cut level 5
- Smooth and tightly woven
- Set of 1 pair

Every installer knows the problem: accidentally cutting your hand or fingers. When large sheets of , cardboard or plastic panels have to be cut, there is a risk of accidentally cutting your fingers. This can be avoided using the ANTI-CUT Glove. This glove is woven with a smooth fibre that prevents sharp objects from passing through it.



Price per unit



Seamless application glove, made of elastic material. The white material helps you to check whether the surface and/ or the vinyl is clean. Because of the perfect fit it gives you the necessary feeling that you need during your application work, especially when you deal with curved surfaces on cars. The glove is made of dust free material, so even touching the adhesive of the vinyl will not cause any residue to be left behind.



QUICK TIPS

Available in 3 sizes:

Medium	400-252	Price per set
Large	400-253	Price per set
X-Large	400-254	Price per set



Have you ever had small creases pop up at the corners of a wrap? Or small overlaps that lose their adhesion? This practical tool is intended for releasing the tension off installed edges around corners. The CornerSealer allows you to melt small creases or curly edges and close or flatten them.



QUICK TIPS

ABS housing Pocket-size Works on 2 alkaline batteries (not included)

HOW TO USE:

1. Make sure is clean and degreased
2. Activate the device to preheat the flat head. This takes about 10-15 seconds (preheating time increases with deteriorating batteries). **ATTENTION! Head can get hot!**
3. Avoid skin contact to prevent injury
4. Place the flat head against the area and push down firmly
5. Avoid overheating! 1-3 seconds of pressing is usually sufficient

Price per unit



Cutting Mat - Triple Layer

250 - SERIES

- 3 mm (120 mil) thick double layer calibrated cutting mat
- Available in black, green and transparent

High quality cutting mat which closes after every cut, preventing your knife from following previous cuts. These mats are triple layer enabling both sides to be used. So they'll last twice as long!

Green

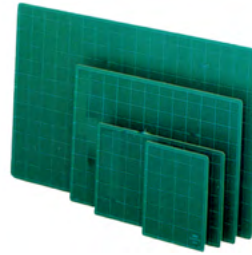

250-010 30 x 45 cm
250-014 45 x 60 cm
250-016 60 x 90 cm

Transparent



250-012 30 x 45 cm
250-015 45 x 60 cm
250-018 60 x 90 cm

Black

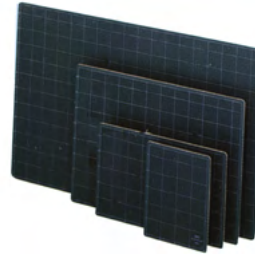

250-011 30 x 45 cm
250-013 45 x 60 cm
250-017 60 x 90 cm

Price per unit

OLFA® Cutting Mat Multi - Purpose Self - Healing Craft **OLFA**

250-CM SERIES

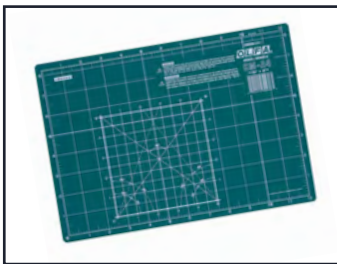

- One side shows cm, other side shows inches

CM series multi-purpose self-healing cutting mats are 2 mm thick and specially designed for use with OLFA standard duty cutters, heavy-duty cutters, art knives, rotary cutters and specialty cutters. Double-sided with green base color and white grid lines with a metric grid on one side and an inch grid on the other. Grid lines are designed for easy measuring and for accurate cutting of straight lines and precise angles. Self-healing, an OLFA original technology refers to the ability of the surface to return to its original shape after being cut and are ideal for general quilt cutting. A three-layer structure and soft cutting surface realize smooth cutting even after many years of use. OLFA CM mats protect your work area and greatly extend the life of your blades.

QUICK TIPS

WARNING!

- Keep the mats away from sunlight and heat
- Mats must be stored flat
- Not suitable for use with steam irons
- Not suitable for use with OLFA MC-45 and MC-45/DX

250-CM-A4	20 cm x 30 cm	Price per unit
250-CM-A3	20 cm x 45 cm	Price per unit
250-CM-A2	45 cm x 60 cm	Price per unit
250-CM-A1	60 cm x 90 cm	Price per unit

Professional Roll Support **SOTT**

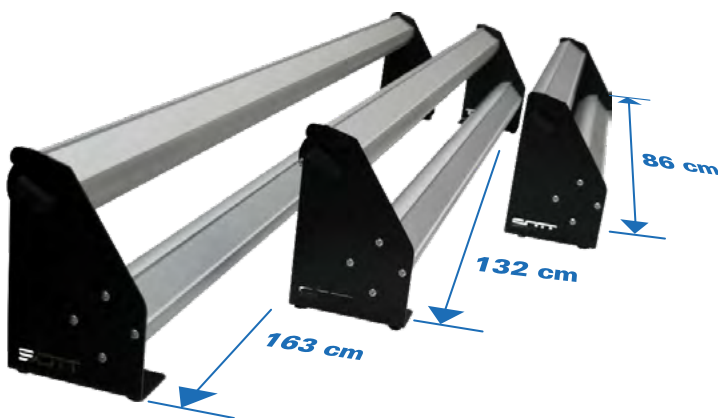

Amazingly practical tool for unrolling application tape, car wrap or windows on your cutting table.

Heavy duty anodized aluminium dispenser with black coated steel side plates. Perfect for application tape or unwinding rolls of window and vinyl. Specially made for rolls of vinyl with a 3-core.

500-SRS86	86 cm	Price per unit
500-SRS132	132 cm	Price per unit
500-SRS162	162 cm	Price per unit



- Everything you need, carried in 1 toolbox

A standard toolbox can't contain all the tools you need during a carwrap job. As always, you just don't have not enough compartments for your special knives and squeegees, bottles will topple over and so on. But not anymore! Now you can have the SOTT ToolBox.

Price per unit

Toolbag Mini



**- 4 Storage compartments
- Belt included**

This mini tool bag has a width of 13 cm and is ideal for installers who only need few a different tools for their installations. The tool bag has 3 compartments on the front and a hidden compartment on the back. On the front there is also a loop to attach a tape measurer.

QUICK TIPS Belt included 

Price per unit

SOTT® Professional Toolbag SOTT



**- The most versatile toolbag available
- Belt not included**

Professional installers often find themselves doing acrobatic feats to get to their tools whilst working. SOTT wants to respond to the needs of installers. So SOTT designed a special ToolBag which fully meets the requirements of professional installers across Europe.

QUICK TIPS Use with:  
400-017S 400-022

Price per unit

Razor Blade Scraper - Metal Body



- Steel body

Elegant metal scraper which takes razor blades. The blade can be exposed for work or safely withdrawn with one thumb movement. Ideal for small windows and windscreens.

The following razor blades can be used: 300-004.

Price per unit



OLFA® XSR Extra Heavy Duty Scraper **OLFA**

- 100 mm(4") wide - In 3 different versions

Developed on request by industry professionals, hard working scraper with handle features extra-tough, die-cast metal handles, rounded with X-design non-slip rubber grip for comfort and stability and engineered with a built-in durable steel striking hammer tip for maximum striking power. Optimal size for centralized use on tough removal projects.

Includes 100 mm wide dual-scrape, carbon tool steel blade BS for maximum coverage and speed - use either sharp side or rough-edged side, depending on the job. Also fits flexible BSF blades (sold separately).

300-050



300-051

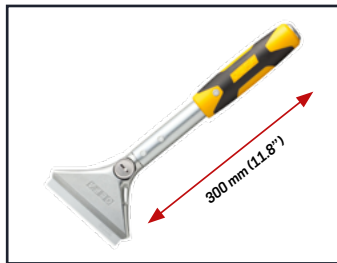

300-052

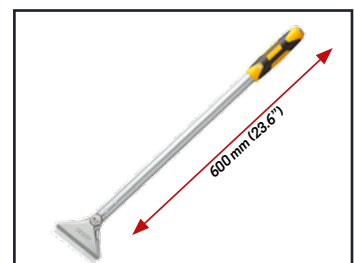

QUICK TIPS

Recommended razor blades:

120-BS-10B

120-BS-08/6B

120-BSF-6B

120-LB10

300-050
300-051
300-052

200 mm length
300 mm length
600 mm length

Price per unit
Price per unit
Price per unit

Surface Cleaner II **SOTT**

600-SC02FLES



- Developed especially for professional installers of all type of s
- Cleans car paint, metal, plastic, glass, bisonyl, etc.
- Biodegradable

SOTT Surface Cleaner II is the number one cleaner in the self-adhesive industry. It meets all of the demands of the installer; just spray Surface Cleaner II on any surface.

It loosens the dirt and can be removed with a dry cloth. Surface Cleaner works fast and dries during polishing. No stripes, lines or dirt getting spread around. Just grab the SOTT Surface Cleaner II, spray, wipe with a dry cloth, job done!

This universal cleaner certainly lives up to its name: it can clean any surface, removing dirt, grease, adhesive residue. This product has been developed in accordance with the latest European standards and legislation, and conforms to all current environmental requirements.

Price per unit

Industrial Degreaser - Silicone Cleaner **SOTT**

600-T800FLES



- Harmless for car paints
- Removes silicone, grease, tar, oil, adhesive, paraffin and car importer's wax

A unique balanced product that was especially commissioned and developed over 20 years ago for use in the metal fabrication, automotive and advertising industries. Used extensively in the metal fabrication industry for degreasing prior to chroming or galvanizing. SO THIS IS A REAL DEGREASER!

Price per unit

Silicon - Wax Remover

600-T900



- The best solution for removing stubborn wax

Durable surfaces such as car paint are often treated with a protective layer. The most conventional way to do this is to use a silicone-based wax. Since silicone has a repellent effect, this is ideal to prevent dirt. However, self-adhesive materials such as stickers, strips and wrap s will also no longer be able to adhere.

To be able to do this, the wax must be removed. SOTT 600-T900 Industrial Silicon & Wax Remover ensures that the wax becomes soft and dissolves, so that it can then be removed with a soft cloth.

Price per unit

Roll Dispenser

500-050



- Indispensable in every workshop

Metal dispenser for rolls of triple layer polishing paper (300-040). This handy dispenser holds a roll of polishing paper and allows individual sheets to be torn off across a black perforated guide at the top. The dispenser can be folded for easy transportation.



QUICK TIPS

Suitable for:



300-040

Price per unit

SOTT® Polishing Paper - Triple Layer SOTT

300-040

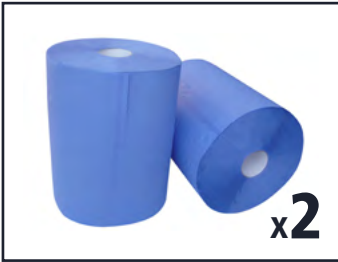

- 2 Rolls -37 cm (1'3") wide

Industrial grade triple layer highly absorbent polishing paper. This paper is extremely strong and will not disintegrate when saturated with water. Soft but strong. Indispensable in every workshop.



This high quality compactly rolled polishing paper is extremely soft and so will not scratch the substrate.



QUICK TIPS

Suitable for:



500-050

Price per pack

Lowtack Tack Rags - On a Roll

300-023



- Removes all dust from any surface - Leaves no residue

Slightly sticky cloth. Perfect for removing dirt and dust of window frames, cars or any area which has to be dust and dirt free before applying s. Will not leave any residue behind. Contributes to a static-free surface.

One side is slightly adhesive. Leaves no residue.



LowTack tack rags on a roll are the perfect solution for removing dust from a variety of surfaces. Individual perforated sheets.

Price per unit



QUICK TIPS

Roll length: 36 m (62 sheets)

Tack Cloth Dust - Fix

300-022



- 10 Pack

Slightly sticky cloth. Perfect for removing dirt and dust of window frames, cars or any area which has to be dust and dirt free before applying s. Will not leave any residue behind. Contributes to a static-free surface.

Price per pack



Cover Styl Starter Kit

Prepare the ground with our starter kit for installing Cover Styl decorative adhesives. Make your life easier with this kit that includes all the tools needed to achieve a high quality installation.

150-CS13

Cover Styl Squeegee
13 cm



150-CSF-13

Felt Pad 13 cm with
Cover Styl Logo



120-DB

SOTT Snap-Off Blade



100-SVR-2

OLFA Professional Cutter
45° auto lock



120-AB-50S

OLFA Snap-Off Stainless
Steel Blades 45° - 50 Pcs



600-SC02FLES

SOTT Surface Cleaner-II
1L + trigger



100-023

SOTT Backing Cutter



100-024

NT Backing Slitter



600-P1000N

High Tack Bond Primer
1L



600-PMR250

Cover Styl Primer +
250ml



PMR-1000-PRO

Toolbag Mini



400-HL2020E

STEINEL
Heat Gun Digital 2200 W



600-PMR40

Primer+ Stick



400-255

Toolbag Mini



100-NP-2

Air Release Tool Black



400-253

SOTT
Application Glove
Medium



250-CG90

Marker Guide 90°





Cover Styl

Cover Styl Expert Kit

Prepare your worksite with our starter kit for installing Cover Styl decorative adhesives. Make your life easier with this kit that includes all the tools needed to achieve a high quality installation.

150-CS13

Cover Styl Squeegee
13 cm



150-CSF-13

Felt Pad 13 cm with
Cover Styl Logo



120-DB

SOTT Snap-Off Blade



100-SVR-2

OLFA Professional Cutter
45° Auto Lock



120-AB-50S

OLFA Snap-Off Stainless
Steel Blades 45°
50 Pcs



600-SC02FLES

SOTT Surface Cleaner-II
1L + Trigger



100-023

SOTT Backing Cutter



100-024

NT Backing Slitter



600-P3000

High Tack Bond Primer
3 L



600-PMR1000

Cover Styl Primer +
250ml



PMR-1000-PRO

ISO Base Primer
250ml



400-HL2020E

STEINEL
Heat Gun Digital 2200 W



600-PMR40

Primer+ Stick



400-255

Toolbag Mini



400-253

SOTT
Application Glove
Medium



250-CG90

Marker Guides 90°



100-NP-2

Air Release Tool
Black



300-022

Tack Cloth Dust-Fix



300-003

Razor Blade Scraper
Metal Body



300-004

Razor Blades
Single Edge



250-CB50

The Yellow-5 Cutting
Ruler 50 cm



250-CB200

The Yellow-5 Cutting
Ruler 200 cm



250-016

Cutting Mat - Triple Layer
60 cm x 90 cm Green

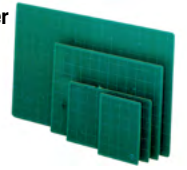

150-035

5-Way Tool

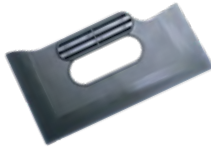

150-101

The Finisher



400-018S

SOTT ToolBox



400-HLGuard

STEINEL Guard Cage



400-CS01

The Corner Sealer



600-MCS

Mastic Cover Styl
1,8 kg



150-CSP6

Spatula for Mastic
6 cm



150-CSP13

Spatula for Mastic
13 cm





SOLAR SCREEN

SMART FILM SOLUTIONS



SOLAR SCREEN
INTERNATIONAL S.A.

18, rue du commerce
L-3895 FOETZ - LUXEMBOURG
Tel.: + 352 26 00 84 82