

EURODROF

3D coating desktop machines

high performance polyurethane coating resins

POLY Drop

The edge **self-leveling** quality of our resin makes the process fast and easy

The **accurate control** of the resin flow guarantees professional results and many intriguing applications.

Sign Lettering

Labels Production

Jewel Stones for Fabrics

8 YEARS OUTDOOR GUARANTEE
unique on the market
versatile and maintenance free

POLY MIX

Necessary mixer pump that mixes and prepares Poly Drop Resin to be applied to labels with our manual, semi-automatic and automatic Poly Dose.



How it works. - Features - Benefits.



VERSATILE.
MINIMIZE THE WASTE WHEN SAMPLING.

Weight two components resin in an inexpensive disposable container.

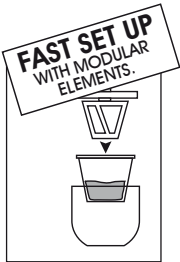

FAST SET UP
WITH MODULAR ELEMENTS.

Insert in the mug exterior container and cover with mug top.



MIX IN 5 MIN.
Gr. 40 UP TO gr. 600 OF ANY POLYDROP RESIN.

Vacuumize & Mix the resin in the disposable. Alarm and stop when mixing completed.



NO SOLVENT
MAINTENANCE OF CLEANING.

During operation exterior and top mug rest both clean and don't need clean up.

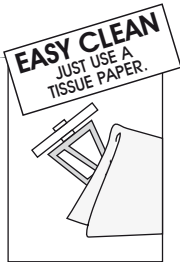

EASY CLEAN
JUST USE A TISSUE PAPER.

After the mix clean up only the steel spatula with tissue paper.



BUDGET
USE UNEXPENSIVE CONTAINER.

POLY DOSE

Manual and automatic dispensers that allow operator to rapidly create polyurethane domed labels and decals in any shape and in various sizes.

Precise control of air pressure, time and size of needles ensure consistent deposits, speeding up output, with high quality and reduced waste.

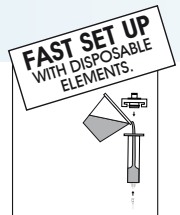

FAST SET UP
WITH DISPOSABLE ELEMENTS.

Refill in few seconds using the same inexpensive syringe.

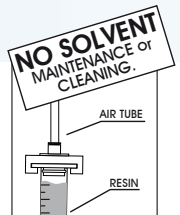

NO SOLVENT
MAINTENANCE OF CLEANING.

During operation air tube rest clean.



NO CLEAN UP
AFTER OPERATIONS.

Syringes, container and needles are disposable.

FreeDrop

Professional Manual Pneumatic Entry Level **POLY DOSE**

How it works. - Features - Benefits.

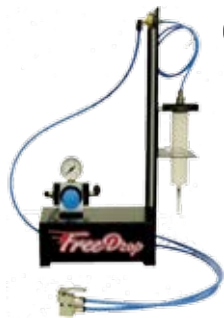

The FreeDrop function enables production of domed emblems in any shape in a easy and intuitive way. The pressure regulator and the hand lever control guarantee accurate flow and precision on scripting and other intricate layout.

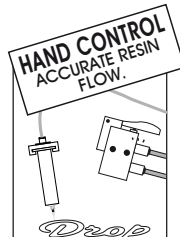

HAND CONTROL
ACCURATE RESIN FLOW.

The precise control it allows to dome vinyl lettering in any size and shape.

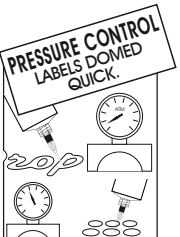

PRESSURE CONTROL
LABELS DOMED QUICK.

Air pressure & various size of needles ensure consistent deposits.



VERSATILE
MANY RESIN AVAILABLE

The variety of resin allows many intriguing applications.

Label Drop

Electro-Pneumatic Semi-Automatic and Automatic **POLY DOSE**

How it works. - Features - Benefits.



Automatic continuous timed Drop function with regulable pause. Allows operator to dome a complete sheet of regular shaped multiple labels with only one press of the foot control. The operator produces thousands of labels in a fast and relaxed way. During operation the resin drop may be immediately interrupted by releasing the foot lever control.



LABELS DOMED QUICK WITH FOOT CONTROL

The precision of the foot control makes faster run series of domed label.



NEEDLE CLEAN THANKS VACUUM DEVICE

When the foot control is released, the unit starts the vacuum avoiding occasional resin dripping.



SAMPLES IN MINUTES

Set the necessary quantity it's easy thanks the good flow of the resin.

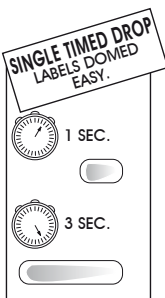

SINGLE TIMED DROP
LABELS DOMED EASY.

WITH THE SINGLE TIME FUNCTION, E35 DISPENSES THE SAME QUANTITY OF RESIN ON EACH LABELS.

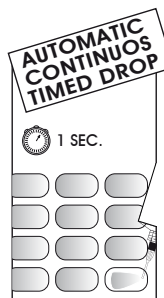

AUTOMATIC CONTINUOUS TIMED DROP
FUNCTION WITH REGULABLE ELECTRONIC PAUSE. COMPLETE SHEET OF REGULAR SHAPED MULTIPLE LABELS WITH ONE PRESS OF THE FOOT LEVER CONTROL.



THOUSAND OF LABELS

HOME 1 THOUSAND OF LABELS IN 1 HOUR, THANKS THE AUTOMATIC CONTINUOUS DROP FUNCTION.

Label Drop Productivity:

The resin is controlled both manually and automatically. With 1 gram it is possible to coat a 5 SQCM 1,8 high.

- In 1 Hour the productivity is about:
- 1400 round labels ø 17 mm.
 - 900 square labels 25X25 mm.
 - 650 rectangular labels 50X20 mm.

Poly Drop 2 components PU resin that enhances the appearance of Nameplates, Labels, and Signs Made in Vinyl, Polyester, Polycarbonate, Abs, Alluminium and other material used in graphic industry.

CRYSTAL CLEAR SERIES

When dispensed will flow to the edge, stop and self-level producing a 2 mm. high build, crystal clear lensig effect. Cure rapidly at room temperature. When cured the PU Drop has an excellent smooth / slippery surface it exhibits superior resistance to degradation or discoloration when exposed to UV rays or harsh enviromental conditions.

Resin is packed in a convenient 1 kg. can. The shelf life of an unopened can is 18 months. Cans can be re-open within 6 months from first use



BigLabel

8 year outdoor flexible clear PU resin designed to produce 3D labels that meet automotive spec. It allows to dome transfer Filmrex F97 for fabrics.

FLEXIBLE
Washable,
Conformable



HARD EMBLEMS

8 year outdoor semirigid clear PU resin designed to dome vinyl and other plastic substrates.

SEMIRIGID
Hard
Finishing



No matter the layout of your artwork or the complexity of your application there is always a Poly Drop Resin designed to fit your need.

SPECIAL EFFECT SERIES

Poly Drop PU Pigments create visual impact, drive aesthetic trend and improve brand recognition and product differentiation. Those unique pigments manipulate light energy to deliver depth, luster, spark, multicolor play and other striking visual effect.

Murano

10 Vibrant PU Pigments designed to create coloured glass look or coloured metallic look emblems for outdoor.



CUT DROP EXAMPLE



SIGN LETTERING: MURANO COLORS ON ADHESIVE SILVER FILMREX F50.

PRINT DROP EXAMPLE



PRINTED 3D STICKER WITH OUTLINE MADE BY MURANO COLORS.

TEX DROP EXAMPLE



FASHION LOGO: MURANO COLORS ON THERMO ADHESIVE FILMREX F97.

CARRARA

PU Pigments designed to create WHITE pearlescence, iridescence or a marble look emblems.



CUT DROP EXAMPLE



SIGN LETTERING: CARRARA COLORS ON ADHESIVE SILVER FILMREX F50.

PRINT DROP EXAMPLE



PRINTED 3D STICKER WITH OUTLINE MADE BY CARRARA COLORS.

TEX DROP EXAMPLE

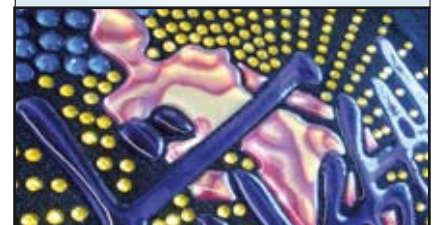

FASHION ACCENT: MURANO COLORS ON THERMO ADHESIVE FILMREX F97 .

Glitter

6 Glitter with coloured brightness, transparency and reflectivity designed to create a sparkling starlike on your print emblems.



POLYMIX IS REQUIRED TO USE ALL POLYDROP RESIN.

POLYDROP RESINS ARE 100% COMPATIBLE AND SHOW FAST DISPERSION.

Pick a colour, any colour, and add to any Crystal Clear Resin.

Colour that radiates with shine and stays extraordinarily true up to 8 Years.

EASY LEVEL DUST FREE

State of art levelled working/curing stackable table overlay.

How it works. - Features - Benefits.

Apply the 4 adjustable Easy Level feet to any Dust Free Tray and obtain a state of art levelled working or curing base to overlay the table.

These robust trays are designed with 4 bends and equipped with anti-slip feet to be stackable on the base saving space and avoiding dust contaminations. They may also be used in **FAST CURE** ovens.

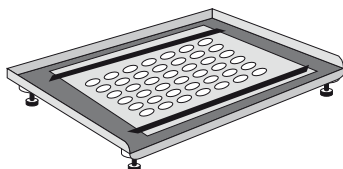

They maintain labels dust free reducing waste. They allow an easy level set-up just by fixing labels sheets with the included magnetic stripes. This setting will prevent waste avoiding roll memory.

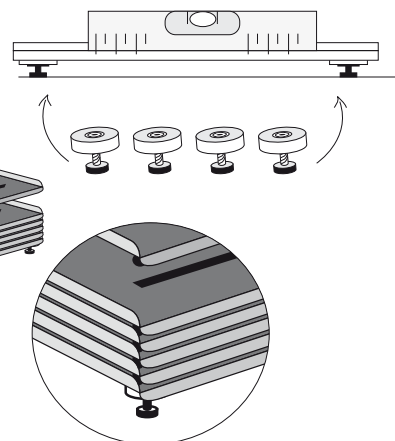
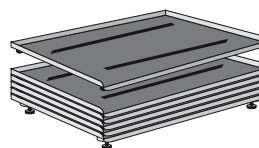

Available sizes:

EASY LEVEL DUST FREE SMALL Set of 10 small trays cm. 40 x cm. 25 with 4 magnetic adjustable feet and 20 magnetic stripes. Designed to produce small 3D emblems.

EASY LEVEL DUST FREE BIG Set of 5 big trays cm. 77 x cm. 40 with 4 magnetic adjustable feet and 20 magnetic stripes. Designed to produce 3D sign lettering.

FAST CURE

These ovens rapidly cure 3D decals within 2 hours

FAST CURE SMALL oven for labels.

Equipped with

EASY LEVEL DUST FREE SMALL

Set of 10 small trays cm. 40 x cm. 25 with 4 magnetic adjustable feet and 20 magnetic stripes.



FAST CURE BIG oven designed for labels and sign lettering.

Equipped with

2 **EASY LEVEL DUST FREE BIG**

Set of 5 big trays cm. 77 x cm. 40 with 4 magnetic adjustable feet and 20 magnetic stripes.

CUT Drop

Adhesive silver For outdoor.

TEX Drop

Special transfer media for Tex Drop applications.

Recommended for best results on lettering. Easy to cut. Easy to weed. Easy to drop. Best silver media for outdoor/indoor 3D resin signs applications.

Transfer media film printable with ecosolvent or solvent inks easy to coat with resin. Once the resin is cured, you can affix by a standard heat press directly on fabrics. These media designed for Tex Drop allow to produce 3D regular logos as well as intricate lettering for clothing.

With SILVER FILMREX F50 you produce coloured 3D metallic emblems for outdoor using Crystal Clear, Murano and Carrara resins.

With WHITE FILMREX F97 you produce 3D Print & Cut heat transfer graphics by using clear resin.

With CLEAR FILMREX F99 you produce 3D heat applied digital cut graphics by using clear or color resin.

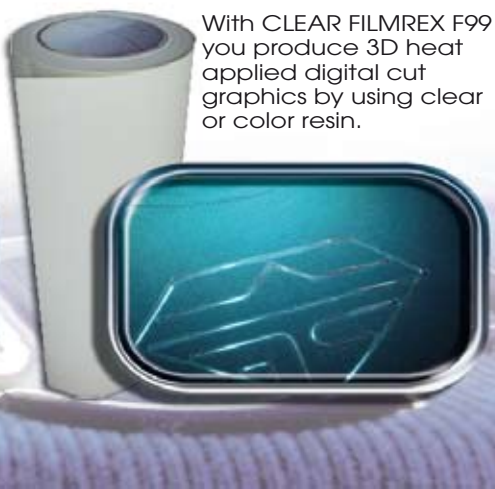

CUT Drop

EXPAND & RESTYLE YOUR SIGNAGE OFFERING & BOOST PROFITS!

? What is!

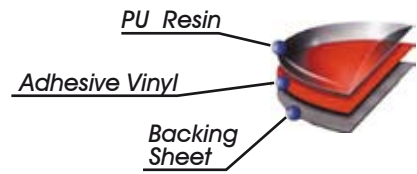

? What you need!

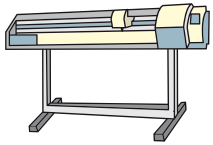

Cutter



Poly Mix

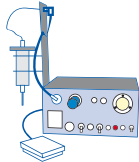

Poly Dose

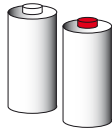

Resin

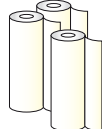

Adhesive Vinyl



? Working Flow!

- 1 - Kiss cut and weed excess vinyl.
- 2 - Mix the two component resin with Poly Mix.
- 3 - Apply the resin with any Poly Dose.

P.S.: For best results on 3D metallic lettering use our SILVER FILMREX F50.

? What you produce!

3D Lettering and 3D prespaced decorative kit for sign and personalization.



PRINT Drop

BRING YOUR PRINT ARTWORK TO A THREE DIMENSIONAL LIFE!

? What is!

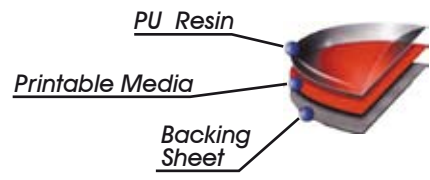

? What you need!

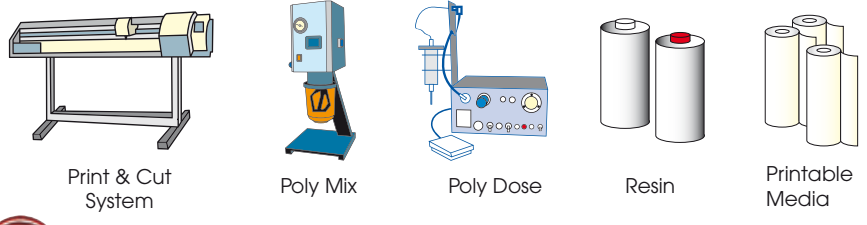

? Working Flow!

- ① - Print, cut and weed excess vinyl.
- ② - Mix the two component resin with Poly Mix
- ③ - Apply the resin with any Poly Dose

? What you produce!

3D Labels and nameplates, 3D vinyl lettering, logos and signs, 3D decorative overlay kit, keychains and corporate gadget customization..



TEX Drop

SPARKLING CUSTOM APPAREL SOLUTIONS THAT SCORE!

? What is!

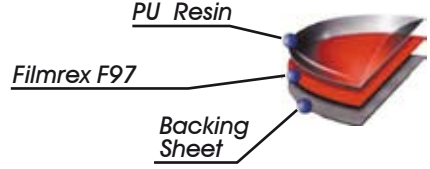

? What you need!

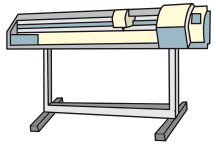

Print & Cut System



Poly Mix

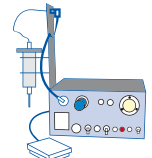

Poly Dose

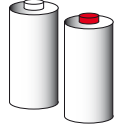

Resin

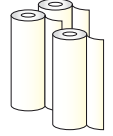

FilmRex F97

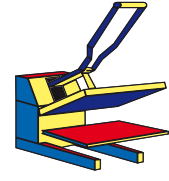

Heat Press



? Working Flow!

- 1 - Print, kiss cut and weed excess Filmrex F97.
- 2 - Mix the two component resin with Poly Mix
- 3 - Apply the resin with any Poly Dose
- 4 - Fix on fabrics with heat press.

? What you produce!

3D heat transfer logos, 3D heat applied cut lettering, 3D prespaced decorative kit for fabrics.

SPORT NAMES

HATS

STONES IMITATION

FASHION DECORATION

FASHION BAGS

COMMERCIAL LOGOS

DJ BAGS

T-SHIRTS

JEWELLERY ON FABRIC

JEWELLERY ON FABRICS

LETTERING ON JACKETS

NEWS CAFE

ORTOFON

SUNCOAST



Companies turn to POLYDROP SYSTEM to change the nature of their products. They get results that change their market and their profit.

The resin's most important features are:

POLYDROP liquid **CRYSTAL CLEAR** polyurethane is **not toxic flexible resin** curable at room temperature that will dent and rebound instead scratching.

Manufactured to high automotive quality standards.

It resists to **UV LIGHT** to with stand years of use in direct sunlight without fading or yellowing.

Resistant to moisture and temperature extremes.

POLYDROP standard **CRYSTAL CLEAR** polyurethane will not crack or harden.

POLYDROP SPECIAL EFFECT manipulates light energy to deliver depth, lustre, sparkle, multicolor play and other striking effects.

10 vibrant *Murano* **colors** to produce coloured, metallic and transparent emblems for outdoor.

Marble **CARRARA** **color** designed to create white pearlescence or a marble look emblems.

6 Pearly *Glitter* **colors** to turn sparkling any graphics.

Those colors offer **limitless styling options** in end-use applications.



**It' easy and profitable
change the nature
of your product.**

EURODROP Sas

35 YEARS
of solutions

Via Sella, 12 - 20094 Corsico (Milano) ITALY

tel. +39 02 45867272 fax. +39 02 45861665

info@eurodrop.it

www.eurodrop.it

www.youtube.com/remarkablecs

